

Regulation 61-56

Onsite Wastewater Systems

Disclaimer

DES provides this copy of the regulation for the convenience of the public and makes every effort to ensure its accuracy. However, this is an unofficial version of the regulation. The regulation's most recent final publication in the *South Carolina State Register* presents the official, legal version of the regulation.



SC DEPARTMENT *of*
ENVIRONMENTAL
SERVICES

Statutory Authority:

S.C. Code Sections 44-1-140(11), 44-1-150, 44-55-825, 44-55-827, and 48-1-10 et seq.

Regulation History as Published in State Register			
Date	Document Number	Volume	Issue
June 7, 1978	-	2	15
June 27, 1986	654	10	6
May 23, 2008	3154	32	5
May 27, 2016	4591	40	5
May 28, 2021	4979	45	5
May 27, 2022	5103	46	5

Table of Contents

100. Purposes and Scope.....	1
101. Definitions and References.....	1
102. Onsite Wastewater System Site Evaluation and Fees	9
103. Onsite Wastewater Systems	11
104. Application, Permit, Final Inspection and Approval, and Variances and Exemptions	12
200. Minimum Site Conditions for Onsite Wastewater Systems.....	15
201. Minimum Requirements for Onsite Wastewater System Primary Treatment.	17
202. Minimum Requirements for Onsite Wastewater System Final Treatment and Disposal Systems	19
203. Onsite Wastewater System Construction Criteria.....	20
204. Evaluation of Alternative Infiltration Trench Products	20
300. Wastewater Treatment Facility Accessibility.....	22
301. Discharge of Waste.....	22
302. Changes in Use That Impact Existing Onsite Wastewater Systems	22
400. Appendices of Standards for Permitted Systems	22
Appendix A – System Standard 100/101 – Conventional with 14-Inch Aggregate Depth.....	22
Appendix B – System Standard 150 – Large (greater than 1500 gpd) and Community Systems	25
Appendix C – System Standard 210/211 – Shallow Placement with 9-Inch Aggregate Depth	27
Appendix D – System Standard 220/221 – Shallow Placement with Six (6)-Inch Aggregate Depth....	30
Appendix E – System Standard 230/231 – Shallow Placement with 14-Inch Aggregate Depth with Fill Cap	33

Appendix F – System Standard 240/241 – Ultra-Shallow Placement with 6-Inch Aggregate Depth with Fill Cap	36
Appendix G – System Standard 250/251 – Reservoir Infiltration System for Soils with Expansive Clay	39
Appendix H – System Standard 260/261 – 9-Inch Shallow Placement System with Fill Cap	43
Appendix I – System Standard 270/271 – Alternative Trench Width and Depth Systems.....	46
Appendix J – System Standard 280/281 – Reservoir Infiltration System for Soils with Expansive Clay Shallow Rock Formations	48
Appendix K – System Standard 290/291 – Alternative Trench Width and Depth Systems with Fill Cap	51
Appendix L – System Standard 370/371 – Shallow Placement with Fill Cap for Sites with Shallow Class IV Soil	54
Appendix M – System Standard 380/381 – Double Aggregate Depth Wastewater Infiltration Trenches	57
Appendix N – System Standard 420/421 – Mounded Infiltration System	59
Appendix O – System Standard 431 – Mounded Fill System	62
Appendix P – System Standard 601 – Elevated Infiltration System.....	68
Appendix Q – System Standard 610 – Specialized Onsite Wastewater System Designs (less than 1500 gpd).....	75
Appendix R – Curtain Drain Standard	76
Appendix S – Nonwater-Carried Sewage Treatment Systems	81
Appendix T – Wastewater Combustion Systems	81
Appendix U – Gray Water Subsurface Reuse Systems.....	82
500. Long-Term Acceptance Rate Standard for Onsite Wastewater Systems.....	83
501. Peak Sewage Flow Rate Standard	84
502. Onsite Wastewater Pump System Standard	86
503. Minimum Design Standards for Tank Construction	89
504. Fiberglass Reinforced Plastic Tanks Standard	96
505. Thermoplastic Tanks Standard.....	98
600. License to Clean Onsite Wastewater Systems, Self-Contained Toilets, and Other Sewage Holding Systems (i.e., Licensing of Pumper/Haulers).....	99
601. Vehicles, Equipment, and Practices	101
602. Records of Operation.....	101
700. License to Construct or Repair Onsite Wastewater Systems	102
701. Continuing Education and Training.....	104

702. Practice, Procedure, and Quality Control.....	104
703. Bonding and Insurance Requirements: Tier 3 Installers	105
704. Transition to Tiered Licensure.....	106
800. Enforcement.....	106
801. Severability Clause.	107

100. Purposes and Scope.

(1) A major factor influencing the health of individuals where public wastewater treatment facilities are not available is the proper onsite treatment and disposal of domestic wastewater. Diseases such as dysentery, cholera, infectious hepatitis, typhoid, and paratyphoid are transmitted through the fecal contamination of food, water, and the land surface largely due to the improper treatment and disposal of domestic wastewater. For this reason, every effort should be made to prevent such hazards and to treat and dispose of all domestic wastewater through the practical application of the most effective technology available.

(2) Safe treatment and disposal of domestic wastewater is necessary to protect the health of families and communities, and to prevent the occurrence of public health nuisances. Domestic wastewater can be rendered ecologically safe and public health can be protected if such wastes are disposed of so that:

(a) They will not contaminate any drinking water supply.

(b) They will not give rise to a public health hazard by being accessible to insects, rodents, or other possible carriers, which may come into contact with food or drinking water.

(c) They will not give rise to a public health hazard by being accessible to children or adults.

(d) They will not violate federal and state laws or regulations governing water pollution or sewage disposal.

(e) They will not pollute or contaminate any waters of the state.

(f) They will not give rise to a public health nuisance.

(3) Where the installation of an onsite wastewater system is necessary, the basic principles of design, construction, installation, operation and maintenance shall be followed.

101. Definitions and References.

101.1. Definitions.

Accessibility - S.C. Code Sections 44-55-1410 and 5-31-2010 authorizes county and municipal governments to determine if a wastewater treatment facility is accessible to properties. Where annexation or easements to cross adjacent property are required to connect to a wastewater treatment facility, the wastewater treatment facility shall not be considered accessible.

Alternative System - A system incorporating design modifications of the proposed subsurface wastewater infiltration trench area (drain field) or absorption trench geometry for the purpose of achieving compliance with required setbacks and offset to the zone of saturation and/or restrictive horizons. No such system shall be utilized unless the Department has established a specific standard.

Alternative Infiltration Trench Products - Products specifically designed to replace or eliminate the aggregate typically utilized in subsurface infiltration trenches. Such products must be approved for use by the Department and must adhere to required equivalency values established herein.

Applicant - A property owner, general contractor or agent representing the property owner, or developer who seeks a permit to construct and operate an onsite wastewater system.

Bond - A sum of money set aside (Surety Bond) to insure completion of work under a contract.

Campground - An organized camp in which campsites are provided for use by the general public or certain groups.

Canal - An artificial waterway used for navigation, drainage, or irrigation.

Cleaning - The removal and transportation of septage from an onsite wastewater system, self-contained toilet, or other sewage holding system to an approved disposal location.

Color Charts (Munsell System or equivalent) - Charts bearing various color chips established by a recognized color system which uses three elements—hue, value, and chroma—to make up a specific color notation. The notation is recorded in the form of hue, value, and chroma (e.g., 10YR 5/6). The three attributes of color are arranged in the system in orderly scales of equal visual steps, which are used to measure and describe color accurately under standard conditions of illumination by comparing soil samples to color chips on various charts.

Construction - The installation, upgrade, or expansion of an onsite wastewater system.

Conventional System - An onsite wastewater system that utilizes a network of conventional wastewater infiltration trenches installed in the naturally occurring soil for the treatment and disposal of domestic wastewater.

Critical Area - S. C. Code Section 48-39-10(J) defines critical area as the following: 1) coastal waters; 2) tidelands; 3) beaches; 4) beach/dune systems which are the areas from the mean high-water mark to the setback line as determined in S. C. Code Section 48-39-280.

Curtain Drain - A subsurface interceptor drain that is installed to collect and redirect groundwater as it flows through the soil profile to an appropriate discharge point.

Department - The South Carolina Department of Health and Environmental Control.

Ditch - A long narrow excavation intended for the purpose of drainage and/or irrigation.

Domestic Wastewater - The untreated liquid and solid human body waste and the liquids generated by water-using fixtures and appliances, including those associated with food service operations. For the purposes of this regulation, domestic wastewater shall not include industrial process wastewater.

Dwelling - A self-contained unit used by one (1) or more households as a home, such as a house, apartment, mobile home, house boat, tiny house, park model RV, RV or camper, or other substantial structure that provides living facilities for one (1) or more persons, including permanent or semi-permanent provisions for living, sleeping, eating, cooking, and sanitation.

Effluent - The liquid discharged from a septic tank, effluent pump station, or other sewage treatment device.

Embankment - A bank of soil with at least two (2) feet of vertical height from top to bottom.

Environmentally Sensitive Waters - Outstanding resource waters (ORW), Shellfish Harvesting Waters (SFH), and Trout-Natural Waters (TN) as defined in R.61-68 and classified in R.61-69, and including lakes greater than forty (40) acres in size and the Atlantic Ocean, regardless of their classifications in R.61-69.

Existing System - An onsite wastewater system, which has received final construction approval or has been serving a legally occupied dwelling or structure.

Expansive Soils - Soils containing significant amounts of expansive-layer clay minerals (smectites) as evidenced in the field by classifications of “Very Sticky,” “Very Plastic” and where “Slickensides” are present when evaluated in accordance with the Field Book. Such soil horizons are considered to be restrictive for onsite wastewater systems.

Failing Onsite Wastewater System - An onsite wastewater system that is discharging effluent in an improper manner or has ceased to function properly.

Fiberglass Reinforced Plastic - A fibrous glass and plastic mixture that exhibits a high strength to weight ratio and is highly resistant to corrosion.

Field Book for Describing and Sampling Soils (Field Book) - A field guide published by the U.S. Department of Agriculture (USDA) Natural Resources Conservation Service (NRCS) for making or reading soil descriptions and for sampling soils, as presently practiced in the USA.

Final Treatment and Disposal - Ultimate disposition of the effluent from a septic tank or other treatment device into the soil.

Flexural Modulus of Elasticity - A measure of stiffness of a material.

Flexural Strength - A measure of the ability of a material to withstand rupture when subjected to bend loading.

Gel Coating - A specially formulated polyester resin, which is pigmented and contains filler materials, the purpose of which is to provide a smooth, pore-free, watertight surface for fiberglass reinforced plastic parts.

Gleying - Bluish, greenish, or grayish colors in the soil profile that are indicative of markedly reduced conditions due to prolonged saturation. This condition can occur in both mottled and unmottled soils, and can be determined by using the gley page of the soil color charts.

Gray Water - Domestic wastewater that is generated by water-using fixtures and appliances such as sinks (excluding kitchen sinks), showers, and laundry but that does not come into direct contact with human excreta or solid organic matter.

Gray Water Subsurface Reuse Systems - A system designed to separately collect and treat gray water and subsequently dispose of gray water by reusing it as part of a subsurface irrigation system. This definition does not include any system designed to reuse gray water for any purpose, or by any means, other than subsurface irrigation. This definition also does not include any system that reuses or recirculates gray water within the confines of (i.e., via the plumbing within) a dwelling unit, building, business, or other structure.

Grease Trap - A device designed to separate and store the oil and grease component of wastewater discharged from facilities that prepare food.

Industrial Process Wastewater - Non-domestic wastewater generated in a commercial or industrial operation that may or may not be combined with domestic wastewater.

License - The official document issued by the Department authorizing a person to be responsible for the construction, repair, or cleaning of onsite wastewater systems, self-contained toilets, and other sewage holding systems.

Licensed Onsite Wastewater System Installer (Installer) - A person authorized under this regulation to construct or repair onsite wastewater systems. The specific scope of activities authorized depends on the installer's tier of licensure, as follows:

(1) Tier 1 - May install all gravity-fed residential onsite wastewater systems. This level is not authorized to conduct repairs on existing onsite wastewater systems.

(2) Tier 2 - May install all Tier 1 systems plus pumps, grease traps, systems with curtain drains, elevated infiltration systems, mounded systems, and all commercial onsite wastewater systems, large onsite wastewater systems, and community onsite wastewater systems. This level is also authorized to conduct repairs on existing onsite wastewater systems.

(3) Tier 3 - May install all Tier 1 and 2 systems plus all Standard 610 - Specialized Onsite Wastewater Systems. This level is also authorized to conduct repairs on existing onsite wastewater systems.

Long-Term Acceptance Rate (LTAR) - The long-term rate, typically expressed in gallons per day (gpd) per square foot of trench bottom area, at which a mature onsite wastewater system can continue to accept effluent without hydraulic failure occurring. This flow rate is a result of the interaction between unsaturated soil hydraulic conductivity and biomat resistance.

Mottling - Morphological features of the soil revealed as spots or blotches of different color or shades of color interspersed with the dominant matrix color.

NSF Standard #14 - A National Sanitation Foundation Standard relating to thermoplastics which have been tested and found satisfactory for potable water supply uses, drains, waste, and vent applications.

Nonwater-Carried Sewage Treatment System - A self-contained system for waste treatment (such as a biological, composting, or incinerating toilet) that stores, treats, and renders human urine and feces inert without the use of water and that is designed to not discharge into the soil, onto the soil surface, into bodies of water, or other external media.

Onsite Wastewater (OSWW) System - A system, generally consisting of a collection sewer, septic tank(s), and subsurface wastewater infiltration area, designed to treat and dispose of domestic wastewater through a combination of natural processes that ultimately result in effluent being transmitted through the soil, renovated, and ultimately discharged to groundwater. An onsite wastewater system shall also include an onsite wastewater system, as described above, for the treatment and disposal of gray water.

(1) Small Onsite Wastewater System - An individual system serving an individually deeded dwelling or business that generates less than fifteen hundred (1500) gpd of domestic wastewater. Management and maintenance of each system is the responsibility of the individual property owner.

(2) Large Onsite Wastewater System (General) - An individual system that treats and disposes of domestic wastewater discharges in excess of fifteen hundred (1500) gpd.

(a) Privately Owned Large System - A large onsite wastewater collection and treatment system that serves one (1) piece of deeded property such as a school, adult residential care facility, rental apartment

complex, shopping center, campground, mobile home park, office complex, etc. Management and maintenance of the system is the responsibility of the individual property owner.

(b) Community (Cluster) System - A wastewater collection and treatment system that provides shared collection, treatment, and disposal of domestic wastewater from multiple parcels or multiple units of individually deeded property. Such a system might serve a small subdivision or a condominium complex. It is imperative with such systems that some form of common ownership and management be established and approved by the Department.

(c) Commercial Onsite Wastewater System - An onsite wastewater system generating domestic wastewater or sewage that serves a facility, other than a private dwelling, intended for the engagement of commerce.

Operation and Maintenance - Activities including tests, measurements, adjustments, replacements, and repairs that are intended to maintain all functional units of the onsite wastewater system in a manner that will allow the system to function as designed.

Other Sewage Holding System - Components of a sewer system or holding tank not related to an onsite wastewater system, including grease traps.

Parent Material - The unconsolidated and chemically weathered mineral or organic matter from which the column of soils is developed by pedogenic processes.

Perched Zone of Saturation (Episaturation) - A zone of saturation above an unsaturated zone.

Permit - A written document or documents issued by the Department authorizing the construction and operation of an onsite wastewater system, nonwater-carried sewage treatment system, wastewater combustion system, or gray water subsurface reuse system under this regulation. The term “permit” includes the permit to construct and the approval to operate, both of which are required prior to operation of a system under this regulation. Upon installation of a permitted system and Department issuance of an approval to operate, the construction and operation permit remains in effect for the life of the onsite wastewater system that it authorizes.

Plasticity - The degree to which “puddled” or reworked soil can be permanently deformed without rupturing. The evaluation is made in accordance with the Field Book by forming a roll (wire) of soil at a water content where the maximum plasticity is expressed.

Primary Treatment - The initial process to separate solids from the liquid, digest organic matter, and store digested solids through a period of detention and biological conditioning of liquid waste.

Professional Soil Classifier (“PSC”) - A person who, by reason of special knowledge of the physical, chemical, and biological sciences applicable to soils as natural bodies and of the methods and principles of soil classification as acquired by soils education and soil classification experience in the formation, morphology, description, and mapping of soils, is qualified to practice soil classifying and has been duly licensed by the South Carolina Soil Classifiers Advisory Council as a Professional Soil Classifier in South Carolina.

Public Entity - Any organizations such as a city, town county, municipality, or special purpose sewer district.

Public Water System - Any publicly or privately owned waterworks system that provides drinking water for human consumption as defined in R.61-58, State Primary Drinking Water Regulations.

Pump Chamber - A watertight, covered receptacle designed and constructed to receive and store the discharge from a septic tank until such time that the effluent is pumped to a final treatment and disposal site.

Pumping and Transporting Vehicle - A vehicle approved by the Department for the cleaning of onsite wastewater systems, self-contained toilets, and other sewage holding systems and the transporting of septage and sewage to an approved disposal site.

Receptor - Any water well or surface water of the state, including estuaries.

Redox Depletions - Morphological features that are formed by the processes of reduction and translocation of iron and manganese oxides in saturated soils. These features may be revealed as spots, blotches, or streaks and are lighter shades of color compared with the dominant matrix color.

Redoximorphic Features - Morphological features that are formed by the processes of reduction, translocation, and oxidation of iron and manganese oxides in saturated soils. These include redox concentrations, redox depletions, and reduced matrices.

Registered Professional Engineer - A person licensed as a Professional Engineer by the South Carolina State Board of Registration for Professional Engineers and Surveyors who, by reason of special knowledge of the mathematical and physical sciences and the principles and methods of engineering analysis and design, acquired by professional education and practical experience, is qualified to practice engineering as attested by the person's license and registration as a Professional Engineer in South Carolina.

Remote Subsurface Wastewater Infiltration Area - A subsurface wastewater infiltration area that is not situated within the legal boundaries of the primary lot or tract that it serves.

Repair - Any work performed on an existing onsite wastewater system for the purposes of correcting a system failure, malfunction, or unauthorized discharge, enhancing system performance, or relocation or replacement of the entire system or system components, provided there are no changes in use that would impact the existing system.

Repair or Replacement Area - An area identified on the permit to construct reserved for the installation of additional wastewater infiltration trenches.

Restrictive Horizon - A soil horizon that is capable of severely retarding the movement of groundwater or effluent and may be brittle and cemented with iron, aluminum, silica, organic matter, or other compounds. Restrictive horizons may occur as fragipans, iron pans, organic pans, or shallow rock formations and are recognized by their resistance in excavation and auger boring.

Resin - Any number of commercially available polyester products used in the manufacture of fiberglass reinforced products which serve to contribute mechanical strength, determine chemical and thermal performance, and prevent abrasion of fibers, and which must be physically and/or chemically determined to be acceptable for the environment, and free from inert filler materials.

Revocation - The permanent withdrawal of rights and privileges granted by a license or an onsite wastewater system permit or approval, as applicable.

Rippable Rock - The rippability of rock material is a measure of its ability to be excavated with conventional excavation equipment (e.g., rubber-tired backhoe).

Saprolite - Soft, friable, thoroughly decomposed rock that has formed in place by chemical weathering, retaining the fabric and structure of the parent rock, and being devoid of expansive clay. Unconsolidated saprolite can be dug using a hand auger or knife. Consolidated saprolite cannot be penetrated with a hand auger or similar tool, and must be dug with a backhoe or other powered equipment.

Sealant - A bonding agent specifically designed to bond joining sections of fiberglass reinforced plastic products to each other in such a manner to create a durable, long-lasting, watertight seal, which does not alter the structural integrity or strength of the two (2) joined fiberglass products.

Self-Contained Toilet - A single or multiple-unit toilet and holding tank combination.

Septage - The mixture of solids and liquids removed during cleaning of a septic tank, grease trap, any other part of an onsite wastewater system, self-contained toilet, or other sewage holding system which receives domestic sewage; this includes the liquid, solid, and semi-solid materials which settle to the bottom of transport containers.

Septic Tank - A watertight, covered receptacle designed and constructed to receive the discharge of domestic wastewater from a building sewer, separate solids from the liquid, digest organic matter, store digested solids through a period of detention and biological conditioning of liquid waste, and allow the effluent to discharge for final treatment and disposal.

Serial Distribution - A method for effluent distribution on sloping terrain that utilizes drop boxes or earthen dams to affect total sequential flow from upper to lower wastewater infiltration trenches.

Sewage - Any liquid waste containing human, animal, vegetable, or chemical matter in suspension or solution from water closets, urinals, lavatories, bathtubs, laundry tubs or devices, floor drains, drinking fountains, or other water-using fixtures.

Site - The area or plot of land identified by a plat, deed, or other legal document specifying lot size and its boundaries that is submitted for evaluation by an applicant in an onsite wastewater system permit application.

Site Evaluation - Evaluation of the soil, geology, zone of saturation, surface waters, topography, structures, and property lines of the proposed location of the onsite wastewater system. The evaluation can be conducted directly by certified Department personnel or the Department may conduct an evaluation through the review of information submitted by a licensed person meeting the criteria of Section 102.1(2)(b) or (c).

Soils Report - A report prepared by a licensed person meeting the criteria of Section 102.1(2)(b) or (c) describing soil and site conditions for the purpose of designing an onsite wastewater system.

Soil Structure - The aggregation of primary soil particles (i.e., sand, silt, and clay) into compound particles or clusters of primary particles which are separated from the adjoining aggregates by surfaces of weakness. In soils with platy structure, the aggregates are plate-like and overlap one another to severely impair permeability. A massive condition can occur in soils containing considerable amounts of clay when a portion of the colloidal material, including clay particles, tends to fill the pore spaces making the soil very dense.

Soil Texture - The relative proportions of the three soil separates (sand, silt, and clay) in a given sample of soil. The percentages of each separate are used to determine which class a particular sample falls into by plotting the intersection of these three values on the U.S. Department of Agriculture (USDA) Natural Resource Conservation Service (NRCS) Textural Triangle.

Standard 610 - Specialized Onsite Wastewater System Design (less than 1500 gpd) - An onsite wastewater system that is certified to function satisfactorily and in accordance with all requirements of this regulation by virtue of it having been designed by a Registered Professional Engineer (PE) licensed in South Carolina with technical input from a licensed person meeting the criteria of Section 102.1(2)(b) or (c). Such systems have limited application and can only be utilized when the required engineering design, certification, and technical soils documentation have been provided to and accepted by the Department.

Standard - A group of requirements developed by the Department that specifies the minimum site conditions and design criteria necessary for the approval of a specific type of onsite wastewater system. A standard may also address minimum design criteria for certain components of onsite wastewater systems as well as methodologies for determining system sizing.

Stickiness - The capacity of soil to adhere to other objects. Stickiness is estimated in accordance with the Field Book at the moisture content that displays the greatest adherence when pressed between the thumb and forefinger.

Subdivision - Means all divisions of a tract or parcel of land into two (2) or more lots, building sites, or other divisions, for the purpose, whether immediate or future, of sale or building development, and includes all division of land involving a new street or a change in existing streets, and includes resubdivision. This definition shall apply whether the lots are to be sold, rented, or leased. This definition shall not apply when the division or partition of the land, or the conveyance of property is pursuant to a will, an intestacy statute, or an order by a probate judge.

Subsurface Wastewater Infiltration Area (Drain Field) - A specific area where a network of wastewater infiltration trenches or other devices of sewage application are installed to provide the final treatment and disposal of effluent.

Suspension - The temporary or indefinite withdrawal or cessation of rights and privileges granted by a license or onsite wastewater system permit or approval, as applicable.

Third-Party - A qualified person or entity, as determined by the Department, that is independent of the parties involved.

Ultimate Tensile Strength - A measure of the resistance of a material to longitudinal stress, measured by the minimum longitudinal stress required to rupture the material.

Upgrade/Expansion - Any work performed on an existing onsite wastewater system for the purposes of increasing the capacity of the system above its original design and/or accommodating wastes of a different character than was originally approved.

Variance - Means a written document issued by the Department that authorizes a modification or waiver of one or more requirements of this regulation, if in the opinion of the Department, a health hazard or nuisance will not result from the modification or waiver.

Wastewater Characteristics - The physical, chemical, and biological parameters and characteristics of domestic wastewater. Physical characteristics include turbidity, color, odor, total suspended solids (TSS),

temperature and fats, oils and grease (FOG). Chemical characteristics include the presence and extent of chemical oxygen demand (COD), total organic carbon (TOC), Total Kjeldahl Nitrogen (TKN), nitrogen, phosphorous, chlorides, sulfates, alkalinity, pH, heavy metals, trace elements, and priority pollutants identified by the U.S. Environmental Protection Agency (EPA). Biological characteristics include biological oxygen demand (BOD), oxygen required for nitrification and microbial population. High strength wastewater is characterized as meeting one (1) or more of the following levels: BOD > 350 mg/l, TSS > 100 mg/l, TKN > 100 mg/l, FOG > 30 mg/l.

Wastewater Combustion System - A self-contained system for wastewater treatment that uses water as a medium for transport and storage. It treats and renders wastewater inert using maceration and incineration.

Wastewater Infiltration Trench - A trench installed in the naturally occurring soil that is utilized for the treatment and disposal of domestic wastewater.

Wastewater Treatment Facility - An accessible publicly or privately owned system of structures, equipment, and related appurtenances that treat, store, or manage wastewater.

Zone of Saturation - Any zone in the soil profile that has soil water pressures that are zero or positive at some time during the year. For the purpose of this regulation, the beginning of such a zone shall be utilized in determining all required vertical separations from the deepest point of effluent application. This zone shall be defined as the shallowest of those points at which either redox depletions of value four (4) or more and chroma two (2) or less appear or gleying is first observed; or, in the absence of other field identification methods, the maximum groundwater elevation as determined by wet season monitoring performed in accordance with criteria approved by the Department.

101.2. References.

The following manufacturing and procedural standards referenced in this regulation are those in force on the effective date of this revision:

- (1) American Society of Agronomy (ASA)
- (2) ASTM International C
- (3) ASTM International D
- (4) CSA Group
- (5) Crop Science Society of America (CSSA)
- (6) International Association of Plumbing and Mechanical Officials (IAPMO)
- (7) National Building Specification (NBS) Voluntary Product Standard PS 15-69
- (8) National Electrical Manufacturers Association (NEMA)
- (9) Soil Science Society of America (SSSA)

102. Onsite Wastewater System Site Evaluation and Fees.

102.1. Site Evaluations.

(1) An applicant for a permit to construct an onsite wastewater system, nonwater-carried sewage treatment system, wastewater combustion system, or gray water subsurface reuse system shall, at the time an application for a permit to construct is submitted to the Department, pay to the Department the site evaluation fee set forth in Section 102.2.

(2) Soil evaluations shall be conducted only by:

(a) A certified Department staff member;

(b) A licensed Professional Soil Classifier or other licensed person qualified to practice soil classifying under S.C. Code 40-65-40(7) and otherwise deemed qualified by the Department who has contracted with the Department. The contractor may not charge a rate more than three (3) times the Department's permit fees; or

(c) A privately hired licensed Professional Soil Classifier or other licensed person qualified to practice professional soil classifying under S.C. Code Section 40-65-40(7), provided that the burden of documenting qualification under S.C. Code Section 40-65-40(7) is on the licensed professional. The licensed professional shall provide to the Department verification of licensure and confirmation from their licensing board that the person is qualified to practice professional soil classifying within the scope of their license. The Department will disallow a soil evaluation from any person not able to provide verification to the Department's satisfaction.

(3) Except as provided in Section 102.1(4) and 102.1(5), an onsite wastewater system layout in accordance with Section 400, Appendices of Standards for Permitted Systems, may be prepared by:

(a) A certified Department staff member;

(b) A Registered Professional Engineer licensed in South Carolina who is not Department staff and has subcontracted with the Department to prepare onsite wastewater system layouts at a rate not more than three (3) times the Department's permit fee; or

(c) A privately hired Registered Professional Engineer licensed in South Carolina or the same licensed person under Section 102.1(2)(b) or (c) who conducted the soil evaluation for the site.

(4) Only a Registered Professional Engineer may design a system and prepare a system layout for Standard 610/611 – Specialized Onsite Wastewater Systems, Standard 150 – Large and Community Onsite Wastewater Systems, nonwater-carried sewage treatment systems, wastewater combustion systems, and gray water subsurface reuse systems.

(5) The Department will not perform a soil evaluation or prepare a system layout for any subdivision or portion of a subdivision with ten (10) or more lots without access to all available utilities. Soil evaluations for any lots that are part of a subdivision with ten (10) or more lots without access to all available utilities must be conducted by a licensed person meeting the criteria of Section 102.1(2)(b) or (c). Proposed system layouts for any lots that are part of a subdivision must be prepared by a third-party Registered Professional Engineer or Professional Soil Classifier meeting the criteria under Section 102.1(3)(b) or (c). The Soils Report and proposed system layout must be submitted with the onsite wastewater system permit application for the purpose of the Department review and issuance of a permit to construct.

102.2. Fees.

The Department shall charge a fee of one hundred and fifty dollars (\$150.00) to evaluate the site of a proposed onsite wastewater system, nonwater-carried sewage treatment system, wastewater combustion system, or gray water subsurface reuse system.

102.3. Other.

Funds derived from these fees shall be used only for the provision of services and accompanying expenses associated with the Department's Bureau of Environmental Health Services programs.

103. Onsite Wastewater Systems.

103.1. General.

(1) Each dwelling, business, or other structure occupied for more than two (2) hours per day shall be provided with an approved method for the treatment and disposal of domestic wastewater.

(2) It shall be the responsibility of the property owner to ensure that a permit to construct and operate any new, upgraded, or expanded onsite wastewater system, nonwater-carried sewage treatment system, wastewater combustion system, or gray water subsurface reuse system is obtained from the Department prior to construction and operation of the system.

(3) No person shall begin construction of a dwelling, business, or other structure to be served by an onsite wastewater system, nonwater-carried sewage treatment system, wastewater combustion system, or gray water subsurface reuse system until a permit to construct and operate such a system is issued by the Department. Mobile or modular structures intended for occupancy shall not be moved onto the site until the permit to construct and operate an onsite wastewater system has been issued.

(4) The property owner shall be required to properly operate and maintain in good working order all onsite wastewater system(s) and their parts and to comply with all terms and conditions of a previously issued permit. System parts may include, but are not limited to, sealed watertight tanks, lid(s), piping, aggregate, pump, and pump components.

(5) An onsite wastewater system serving more than one (1) piece of deeded property shall be considered as a community or cluster collection and treatment system and shall comply with the following:

(a) A permit activity will not occur that is inconsistent with a plan or plan amendment approved under section 208(b) of the Clean Water Act unless the Department finds such variance necessary to protect the public's health, safety, and welfare.

(b) If a public entity owns the system, the entity shall be responsible for the operation, maintenance, and replacement of all components unless otherwise approved by the Department. The Department may consider a request from a private entity or person; however, such proposals must be evaluated on a case-by-case basis. The Department will evaluate the capability of long-term, reliable system operation in its evaluation of a permit request.

(c) If the project is owned by a private entity or person, the Department shall require financial assurances for the operation, maintenance, and replacement of the tank(s) and subsurface wastewater infiltration area system and relevant collection/pumping components.

(d) Sufficient area meeting the minimum requirements for large onsite wastewater systems shall be provided for at least one hundred (100) percent repair or replacement of the primary subsurface wastewater infiltration area.

(e) The collection sewer and pumping portions of a community onsite wastewater system shall receive a separate Construction Permit under R.61-67.300, Standards for Wastewater Facility Construction.

103.2. Large (greater than 1500 gpd) and community onsite wastewater systems incorporating advanced treatment methods, including but not limited to aerobic pre-treatment, lagoons, surface or subsurface drip

irrigation, low pressure pipe distribution and other maintenance intensive methods, shall be required to obtain a Land Application Permit under R.61-9, Water Pollution Control Permits.

103.3. Facilities that generate industrial process or any other non-domestic wastewater shall not be granted a permit under this regulation unless the Department determines that the proposed discharge would not pose a significant environmental risk. In such a determination, the Bureau of Water would determine if the waste may cause a violation of any drinking water standard under R.61-58, State Primary Drinking Water Regulations, or may otherwise adversely affect the health of persons regardless of whether or not the wastewater is to be discharged continuously or intermittently to the onsite wastewater system. Plumbing appurtenances that facilitate the transport of such wastewater, including floor drains, trench drains, utility sinks, equipment drains, or any other conduit shall not be installed in facilities served by onsite wastewater systems unless specifically approved by the Department as a result of the above-described determination.

103.4. Campgrounds.

(1) Onsite wastewater systems serving campgrounds shall comply with all applicable requirements of this regulation. Such campgrounds shall be provided with adequate toilet and bathing facilities, except in those cases where all campsites are furnished with individual sewer service connections, and each site is exclusively designated for use by camping units equipped to access such connections.

(2) Individual sewer service connections shall be part of an approved sewage collection system and shall be equipped with removable, tight fitting covers.

(3) Where individual sewer service connections are not furnished at all campsites, an approved sanitary dump station(s) shall be provided at a convenient location(s) within the campground at the ratio of one (1) dump station per one hundred (100) campsites or fractions thereof.

(a) A dump station shall consist of one (1) or more trapped four (4) inch sewer risers surrounded by a concrete apron having a diameter of at least two (2) feet and sloped to drain. Sewer risers must be equipped with removable, tight fitting covers.

(b) Each dump station shall be equipped with pressurized water to be used for washing the concrete apron. The water outlet shall be protected from back siphonage by a vacuum breaker installed at its highest point, or by other approved means. A sign shall be placed at this water outlet stating: THIS WATER IS FOR CLEANING PURPOSES ONLY.

104. Application, Permit, Final Inspection and Approval, and Variances and Exemptions.

104.1. Application.

(1) The applicant shall furnish, in a format as identified by the Department, complete and accurate information necessary for determining the feasibility of an onsite wastewater system.

(2) The application shall include written permission from the property owner or their legal representative, using a form identified by the Department, for Department representatives to access the property.

(3) A boundary plat, deed, or other legal document specifying the lot size shall be furnished by the applicant. The applicant shall provide a legal description that specifies lot boundary lengths for lots two (2) acres or smaller in size and upon request for any lot greater than two (2) acres in size. When a dwelling or facility is to be served by a remote subsurface wastewater infiltration area, the applicant must provide

appropriate easement(s). An appropriate easement must allow ingress and egress for construction, operation, maintenance, replacement and repair and must run with the land.

(4) Soil boring descriptions, backhoe pits, and soils classifications from specifically identified locations, including other tests or information, shall be required when deemed necessary by the Department.

(5) Backhoe pits shall be required above the Fall Line that separates the Piedmont area from the Coastal Plain as defined by the South Carolina Geological Survey.

(6) Before a site evaluation of the lot is performed by the Department, the applicant shall be required to: clear and mark pertinent property boundary lines and corners; post an identification marker in the front center of the lot; place stakes at the corners of the proposed building; mark the proposed point of stub-out and septic tank as well as proposed drain field area; locate the proposed or existing well location; and identify the proposed location of any additional structures or facilities on the property that may influence the placement and configuration of the onsite wastewater system. A site sketch shall be included on the application or as a separate attachment that reflects the items above and any other items specified on the application. The applicant may be required to clear underbrush from the property in order to facilitate the evaluation.

(7) The Department will not issue a permit if it determines that site conditions are unsuitable for the system layout or permit requested, or if issuance of the permit would otherwise be inconsistent with the requirements of this regulation. The Department also reserves the right to modify a proposed system layout submitted by a licensed person under Section 102.1(3)(c) when deemed appropriate.

104.2. Permit.

(1) It shall be unlawful to construct, upgrade, expand, or operate an onsite wastewater system, nonwater-carried sewage treatment system, wastewater combustion system, or gray water subsurface reuse system unless the Department has issued a permit to construct and approval to operate for the specific construction and operation proposed. The system shall be constructed and operated in accordance with the permit, and the Department must authorize any changes prior to the construction and operation of the system. The applicant shall be required to make a written request for any desired permit modifications. The applicant shall submit a new application with a new site evaluation fee for permit modifications that require an additional site evaluation. The Department may also require a permit to construct and approval to operate for the repair, relocation, or replacement of an onsite wastewater system or its components when deemed necessary, irrespective of whether any change in use impacting the existing onsite wastewater system would occur. The property owner or their legal representative shall notify the Department before relocating or replacing an onsite wastewater system or its components so that the Department may determine whether a permit will be required.

(2) The permitted system shall be constructed and operated according to the specifications and conditions of the permit and in compliance with this regulation.

(3) Permits issued after the effective date of this regulation shall remain valid for a period of five (5) years from the date of issuance, provided the physical character of the property has not changed and the conditions of the original permit can be met. Exceptions may be granted for those permits addressed by other statutes.

104.3. Final Inspections and Approval.

(1) Except in the case of systems designed by a Registered Professional Engineer, all installers shall arrange with the Department in advance a time for a final inspection of an onsite wastewater system that is being installed. It shall be considered a violation of this regulation to cover a system that has not been subject to final Department inspection or installer self-inspection in accordance with this regulation.

(2) Final inspections of onsite wastewater systems to determine compliance with a Department-issued permit to construct shall be conducted by certified Department staff except as follows:

(a) Registered Professional Engineers licensed in South Carolina must conduct final inspections on all systems they design.

(b) Except as provided in 104.3(2)(a), Tier 3 installers may self-inspect systems they install. Tier 3 installers shall comply with Section 702.2 in its entirety.

(c) Except as provided in Section 104.3(2)(a), the Department may, in its discretion, direct Tier 1 and Tier 2 installers with no pending enforcement actions or prior Department findings of violation under Section 800 of this regulation to self-inspect systems they have installed using a process and form directed by the Department. Tier 1 and Tier 2 installers allowed to conduct self-inspections shall comply with Section 702.2 in its entirety. The Department reserves the right to withdraw any direction to Tier 1 and Tier 2 installers to conduct self-inspections at any time.

(3) Documentation of system installations, including certified as-built plans where required, shall be submitted in a Department-approved format within two (2) business days of completing the system installation or within two (2) business days of the installer self-inspection, where applicable.

(4) The licensed system installer shall also sign a statement certifying that the onsite wastewater system was installed as specified in the Department issued permit.

(5) Following final inspection and upon review of all required documentation, the Department will issue an approval to operate for a system installed in compliance with the issued permit to construct and all applicable requirements of this regulation. The Department will not issue an approval to operate if it determines that the system installation is inconsistent with the issued permit to construct or inconsistent with any requirement of this regulation.

104.4. Variances and Exemptions.

(1) The Department may, on a case-by-case basis, approve and issue a variance or exemption from one or more requirements of this regulation upon a finding that:

(a) The granting of the variance or exemption will not compromise protection to human health and the environment.

(b) Because of the characteristics of the site, it is not practical or feasible for the onsite wastewater system to meet the requirements of this regulation without taking into account the current science and best technology available.

(2) A request for variance or exemption must be in writing and include the following:

(a) A detailed description of the regulatory requirements for which the variance or exemption is sought.

(b) Sufficient data to demonstrate to the satisfaction of the Department that compliance with the regulatory requirement will not be practical or feasible.

(3) The Department may request additional information to evaluate the request. A complete variance request will be processed within three (3) business days of receiving the request. If approved, the variance or exemption will be issued in writing and may contain conditions. The Department may revoke issued variances as it deems appropriate to protect human health and the environment.

200. Minimum Site Conditions for Onsite Wastewater Systems.

200.1. Soil texture, depth of soil to restrictive horizons, and depth to the zone of saturation shall meet minimum standards approved by the Department. These characteristics shall be determined using accepted methodologies in the field of soil science.

200.2. Soils exhibiting massive or platy structure, and soils which have been identified as having substantial amounts of expansible layer clay minerals or smectites, are unsuitable for onsite wastewater systems.

200.3. Where the estimated peak sewage flow will not exceed fifteen hundred (1500) gpd, the minimum vertical separation between the deepest point of effluent application and the zone of saturation shall be at least six (6) inches.

200.4. Where the estimated peak sewage flow will exceed fifteen hundred (1500) gpd, the depth to the zone of saturation shall be at least thirty-six (36) inches below the naturally occurring soil surface, and at least six (6) inches below the deepest point of effluent application.

200.5. Depth to rock and other restrictive horizons shall be greater than twelve (12) inches below the deepest point of effluent application.

200.6. Setbacks.

(1) The area of the lot or plot of ground where the onsite wastewater system is to be installed shall be of sufficient size so that no part of the system, excluding solid pipes, will be:

(a) Within five (5) linear feet of a building, or under a driveway or parking area;

(b) Within seventy-five (75) linear feet of a private well;

(c) Within one hundred (100) linear feet of a public well;

(d) Within seventy-five (75) linear feet of the delineated critical area line (tidal waters of coastal waters and tidelands critical areas) as determined by the Department's coastal division; or within seventy-five (75) linear feet of the mean high water (within the banks) elevation (nontidal waters, beach/dune systems and beach critical areas) of an impounded or natural body of water, including streams, canals, and retention ponds;

(e) Within ten (10) feet of upslope and twenty-five (25) feet of down-slope curtain drains;

(f) Within twenty-five (25) feet of a drainage ditch or stormwater treatment system including any detention ponds (determined by maximum water elevation);

(g) Within fifteen (15) feet of piped drainage ditches;

(h) Within fifteen (15) feet of an inground pool;

(i) Within twenty-five (25) feet upslope of a basement; and within fifteen (15) feet of the sides of a basement, except that if foundation drains are present and the elevation of the foundation drain is at the same elevation or lower than the elevation of the trench bottom for the subsurface wastewater infiltration area or repair area, then a twenty-five (25) foot setback from the sides of a basement applies. These setbacks do not apply to a septic tank/pump chamber location or where trench installations are downslope of a basement;

(j) Within fifteen (15) feet of the top of the slope of embankments or cuts of two (2) feet or more vertical height when any part of the wastewater infiltration trench is to be placed higher in elevation than the invert of the cut or embankment;

(k) Within five (5) feet of a property line.

(2) Greater protective offsets shall be required when utilizing certain system standards contained within this regulation.

(3) Prior to permitting the onsite wastewater system, jurisdictional determination of any affected wetlands may be required. Should any part of the proposed onsite wastewater system be located in wetlands, approval from the appropriate permitting agency(s) (e.g., U.S. Army Corps of Engineers, SCDHEC Ocean and Coastal Resource Management, etc.) shall be received, and proof of such provided to the Department.

200.7. In addition to the minimum space required in Section 200.6, minimum repair area shall be set aside as follows:

(1) Any new site meeting the minimum design criteria for an onsite wastewater system shall have a usable repair or replacement area equivalent to at least fifty (50) percent of the size of the original system. Where community onsite wastewater systems are utilized, there must be at least one hundred (100) percent repair or replacement area.

(2) Usable repair or replacement area shall be demonstrated to include suitable soil conditions, and shall be free of impervious materials, buildings, or other improvements, setbacks, easements, and other encroachments that would prevent system construction. The undisturbed area between the wastewater infiltration trenches shall not be credited towards this requirement.

200.8. Multiple, individually owned remote subsurface wastewater infiltration areas may be considered for mass installation in a defined area where the wastewater infiltration trenches will be adjacently located to each other, provided that the combined peak wastewater loading is less than fifteen hundred (1500) gpd. In such cases, each subsurface wastewater infiltration area plot shall be sized such that there is sufficient area for one hundred (100) percent subsurface wastewater infiltration area replacement. Each plot shall be deeded, with all appropriate easements, as a lot in conjunction with the specific unit that it serves, and required protective offsets, as described in Section 200.6, shall apply to each individual remote subsurface wastewater infiltration area. A plan shall be prepared by a Registered Professional Engineer licensed in South Carolina that illustrates the overall plan; specifies the route and identification of effluent sewers and/or force mains; specifies the entity responsible for perpetual maintenance of the sewer lines and mass subsurface wastewater infiltration area; specifies the configuration and identification of the individual subsurface wastewater infiltration area parcels; and specifies the manner in which ingress and egress will be provided to the individual subsurface wastewater infiltration area parcels. When the combined peak

wastewater loading of the adjacently loading subsurface wastewater infiltration area will exceed fifteen hundred (1500) gpd, the project shall be considered as a public (community) collection and treatment system, and the onsite wastewater system must comply with the requirements in Section 103.1(5).

201. Minimum Requirements for Onsite Wastewater System Primary Treatment.

201.1. Septic Tanks.

(1) All persons or firms manufacturing septic tanks for use in South Carolina shall submit detailed plans for each size tank to the Department and shall receive written approval for such tanks prior to their installation in the state.

(2) The design and construction of each septic tank shall be in accordance with minimum standards contained within this regulation.

(3) No septic tank shall be installed which has a net liquid capacity of less than one thousand (1000) gallons. Such tanks shall be sufficient to serve dwellings of four (4) bedrooms or less. Two hundred fifty (250) gallons additional capacity shall be required for each bedroom over four (4).

(4) When multiple dwellings share a common onsite wastewater system, each dwelling unit shall either have its own properly sized septic tank or it must discharge to a larger tank(s) that provides the combined total of the minimum septic tank capacities required for each contributing unit. Exception may be granted when a public entity, or private entity with financial assurances, is approved by the Department to provide operation and maintenance of the system. In such cases, the formula in Section 201.1(5) may be considered.

(5) Septic tanks serving establishments other than individual dwellings shall be sized according to actual peak flow data, when available, or by estimates of peak sewage flow, as set forth in standards established by the Department. For those septic tanks receiving peak flows less than fifteen hundred (1500) gpd, the net liquid capacity shall be calculated by multiplying 1.5 times the peak flow expressed in (gpd). For those septic tanks receiving peak flows between fifteen hundred (1500) and forty-five hundred (4500) gpd, the net liquid capacity shall be calculated as follows:

$$\text{Volume (V)} = 1125 \text{ gal. plus } (0.75 \times \text{Peak Flow(gpd)}).$$

For those septic tanks receiving peak flows in excess of forty-five hundred (4500) gpd, the net liquid capacity shall be at least equal to the peak flow:

$$\text{Volume (V)} = \text{Peak Flow (gpd)}$$

(6) The minimum liquid capacity requirements shall be met by the use of a single septic tank or two (2) or more tanks installed in series. Septic tanks joined in series shall be interconnected by an upper effluent pipe(s) with a minimum diameter of four (4) inches and a lower sludge pipe(s) with a minimum diameter of twelve (12) inches. The upper connection(s) shall be installed level from tank to tank, and the lower sludge pipe connection(s) shall be installed level and shall be placed twelve (12) inches above the bottoms of the tanks. The lower sludge pipe connection(s) can be eliminated if the first tank in series contains at least two-thirds (2/3) of the total required liquid capacity. There shall be no more than two (2) inches of fall from the inlet invert of the first tank to the outlet invert of the last tank in series.

201.2. Grease Traps.

(1) Any new food service facilities permitted under R.61-25, Retail Food Establishments, and served by an onsite wastewater system that is permitted after the effective date of this regulation shall be required to have a properly sized grease trap. This requirement may also apply to new facilities not requiring a food service permit under R.61-25. Exception may be granted in cases where a permitted retail food service establishment performs limited food preparation and/or cooking.

(2) Any existing food service establishment that does not have a grease trap, but experiences an onsite wastewater malfunction as a result of grease accumulation, shall be required to immediately comply with all portions of Section 201 as if it were a new food service facility.

(3) Any food service facility requiring a grease trap shall provide two (2) separate plumbing stub-outs, one serving the food preparation area and the other serving the restrooms. The stub-out from the restrooms shall discharge directly into the main building septic tank. The stub-out from the food preparation area shall discharge directly into the grease trap with the effluent then directed to the main building septic tank. In order to enhance grease separation while the liquids are hot, the grease trap shall be placed as close as possible to the source of wastewater. Garbage grinders shall not be allowed to discharge to such systems.

(4) All grease traps must be directly accessible from the surface, and must be equipped with an extended outlet sanitary tee terminating six (6) to twelve (12) inches above the tank bottom. The minimum access opening shall be eighteen (18) inches in diameter.

(5) All grease traps serving facilities from which the peak sewage flow exceeds fifteen hundred (1500) gpd shall either be dual chambered or individual tanks in series. If dual chambered, both the dividing wall and the second chamber must be equipped with a sanitary tee terminating six (6) to twelve (12) inches above the tank bottom.

(6) It shall be the responsibility of the owner/manager to ensure that the grease trap(s) is cleaned by a licensed septage pumper at frequent intervals to prevent the carryover of grease into other parts of the onsite wastewater system.

(7) Determination of Minimum Net Liquid Capacity

(a) No grease trap used as part of an onsite wastewater system shall have a net liquid capacity of less than one thousand (1000) gallons. Commercial interior-type grease interceptors shall not be utilized in lieu of a properly sized exterior grease trap.

(b) Minimum net liquid capacities of grease traps shall be determined as follows:

$NLC = GPD \times LF \times RF$, where

NLC = Net Liquid Capacity of Grease Trap (gallons)

GPD = Total Maximum Estimated Sewage Flow (gpd)

LF = Loading Factor (the approximate portion of the total maximum daily flow generated in food preparation areas)

0.3 - Schools and Other Institutions

0.4 - Restaurants

0.5 - Retail Food Stores

RF = Minimum Retention and Storage Factor of 2.5 for Onsite Wastewater Systems

201.3. Other Primary Treatment Methods.

The Department, at its discretion, may consider other methods of primary treatment requested by a Registered Professional Engineer where conditions are warranted.

202. Minimum Requirements for Onsite Wastewater System Final Treatment and Disposal Systems.

(1) All pipe utilized in onsite wastewater systems shall meet applicable ASTM standards. All piping utilized in the connection of a septic tank to a subsurface wastewater infiltration area, including that which is utilized in the connection of adjacent wastewater infiltration trenches, whether they be level or serially fed, shall be non-perforated Schedule 40 PVC pipe. Such pipe, excluding force mains, shall be a minimum of three (3) inches in diameter. The connecting pipe shall not be surrounded by aggregate.

(2) At least seven (7) feet of undisturbed earth shall exist between wastewater infiltration trenches.

(3) The aggregate used in onsite wastewater systems shall be a material approved by the Department and shall range in size from one-half (1/2) inch to two and one-half (2 1/2) inches. Fines shall be prohibited. Tire chips shall range in size from one-half (1/2) inch to four (4) inches in size, and wire strands shall not protrude more than one-half (1/2) inch from the sides.

(4) Drop boxes shall be utilized when deemed necessary by the Department. When required, they shall be surrounded and stabilized by at least two (2) feet of undisturbed or manually compacted earth, and the wastewater infiltration trenches shall be fed with non-perforated Schedule 40 PVC pipe. The invert of the drop box overflow pipe shall be at the same elevation as the top of the aggregate in the trenches fed by that box, and the top of the aggregate shall be level throughout the trench run. Other methods that affect serial distribution shall also overflow at the same elevation as the top of the aggregate.

(5) There shall be at least two (2) feet of earthen buffer between the septic tank and all portions of adjacent wastewater infiltration trenches. Where gravity flow is utilized, the invert elevation of the septic tank outlet shall be at the same elevation or higher than the top of the aggregate in the highest placed wastewater infiltration trench.

(6) To ensure proper operation and protection of onsite wastewater systems, the Department may require individual or combined installation of drainage swales, curtain or interceptor drains, protective barriers, or protective ground cover. Final approval of the permit may be withheld until such time as these improvements are completed.

(7) The bottom of each wastewater infiltration trench, including the distribution pipe contained within, shall be as level as possible, with an elevation differential not to exceed two (2) inches throughout the trench run.

(8) The required number, length, and configuration of wastewater infiltration trenches shall be determined by the Department and shall be based upon the Standard for Determining Peak Sewage Flow Rates (Section 501, Peak Sewage Flow Rate Standard) from Commercial and Recreational Establishments in conjunction with the Long-Term Acceptance Rate Standard for Onsite Wastewater Systems (Section 500, Long-Term Acceptance Rate Standard for Onsite Wastewater Systems). All systems shall be sized based upon the most hydraulically limiting, naturally occurring soil texture from the ground surface to twelve (12) inches below the bottom of the proposed wastewater infiltration trenches.

(9) The aggregate over the distribution pipe shall be covered with a strong, untreated pervious material to prevent infiltration of backfill material.

203. Onsite Wastewater System Construction Criteria.

203.1. On sloping terrain, wastewater infiltration trenches shall be installed perpendicular to the direction of slope and parallel to the contours of the land.

203.2. Where deemed necessary by the Department, all required site alterations (swales, fill, shaping, etc.) shall be done prior to permitting the installation of the onsite wastewater system.

203.3. The area in which the onsite wastewater system is to be located shall be protected from surface water and roof or downspout drainage by the installation of drainage swales and small amounts of fill to achieve positive surface drainage.

203.4. Gross amounts of dirt, mud, and debris shall be removed from the septic tank before backfilling. All backfilling around the tank shall be tamped to facilitate stabilization.

203.5. If septic tank lids are of multi-part, slab-type construction, all joints shall be caulked or covered with heavy roofing paper or similar material.

203.6. All septic tanks of two-piece construction joined by tongue and groove shall be sealed with either bituminous mastic or other watertight caulking material placed in the groove in such quantity that the sealant is clearly visible around the entire tank after the two (2) pieces are joined.

203.7. When effluent pumping is required, all components of the pumping system shall adhere to standards contained within this regulation.

203.8. The Department may restrict, delay, or prohibit the installation or final approval of any onsite wastewater system when adverse soil or site conditions exist. These may include, but not be limited to, wet soil conditions in textural Class III and Class IV as described in the Long-Term Acceptance Rate Standard for Onsite Wastewater Systems approved by the Department.

204. Evaluation of Alternative Infiltration Trench Products.

The Department shall be responsible for the evaluation and approval of alternative infiltration trench products prior to their use in the state, unless otherwise regulated by statute. This evaluation shall include a review of available research data; a review of parameters relating to structure, geometry, and volume; and the establishment of required equivalency values for comparing the product to a conventional wastewater infiltration trench.

204.1. Application.

(1) All requests for approval of alternative infiltration trench products must be submitted in writing to the Department and must include the following:

- (a) Complete description of the product and its intended use.
- (b) Complete listing of materials used in the construction of the product, including specifications.

(c) Copies of all available literature pertaining to the product and a listing of all appropriate reference materials.

(d) Copies of any and all available research, testing, and monitoring data, to include records of performance and/or prior experience in actual field conditions.

(2) The Department will review the application and may seek other information, including additional evaluations.

204.2. Equivalency Value for Infiltrative Surface.

(1) The total infiltrative surface area surrounding the sides and bottom of a conventional wastewater infiltration trench (i.e., 5.33 sq.ft./lin.ft.) shall serve as the basis for all geometric comparisons to alternative infiltration trench products.

(2) The effective infiltrative surface area of a conventional trench shall include the total of both rectangular sidewalls, beginning at the top of the aggregate and extending to the trench bottom, in addition to the width of the trench bottom. Similarly, the effective infiltrative surface area of a product shall include the total of both immediately adjacent, rectangular sidewalls, beginning at the top of louvers, slits, holes or similar orifices, in addition to the rectangular width of the trench immediately beneath the product.

(3) The equivalency value (E) for any given product is determined by comparing the total effective surface area of the product, as defined above, with that of a conventional wastewater infiltration trench as follows:

(a) Total Infiltrative Surface Area for One (1) Foot of Conventional Trench:

$$\text{Trench Sidewalls} = 2 \times (1.16\text{ft.H} \times 1.0 \text{ ft.L}) = 2.33 \text{ sq.ft./lin.ft.}$$

$$\text{Trench Bottom} = 1 \times (3\text{ft.W} \times 1\text{ft.L}) = 3.0 \text{ sq.ft./lin.ft.}$$

$$\text{Total Infiltrative Surface Area} = 5.33 \text{ sq.ft./lin.ft.}$$

(b) Equivalency Value (E) Shall Be Computed As Follows:

$$E = 5.33 \text{ sq.ft./ft} \div \text{Sum of Three Rectangular Interfaces Immediately Adjacent to Product (sq.ft./ft.)}$$

(c) The Required Total Length of the Product Shall Be Calculated As Follows:

Length of Product (L) = E x Length of Conventional 36 in. Wide Trenches Required by DHEC Regulations and Standards

204.3. Other parameters to be evaluated for alternative infiltration trench products may include the following:

(1) Structural Integrity - Products must be of sound construction and able to adequately withstand the normal pressures and stresses associated with installation and use.

(2) Inertness - No product can be approved unless it will remain relatively unaffected for extended periods of time while in contact with typical domestic wastewater.

(3) Storage Volume - The effluent storage capacity of a product must closely approximate or exceed that of a comparable conventional system.

(4) Maintenance of Permeable Interfaces - A product shall have a direct interface with the effective infiltrative surface (undisturbed natural soil) or, if backfill is required, backfill material shall not create a permeability barrier and shall not hinder the downward or horizontal flow of effluent into the undisturbed natural soil.

(5) The unique characteristics of a given product may warrant the evaluation of other parameters not specifically mentioned in this section of the regulation.

(6) The design, construction, or installation methods used with any product shall not conflict nor violate any other requirements established by the Department.

204.4. Approval for General Use.

If warranted, the Department will issue a letter of approval for general use of the alternative infiltration trench product in accordance with equivalency values and other requirements determined herein. At least nine (9) inches of soil cover is required.

300. Wastewater Treatment Facility Accessibility.

300.1. Permits for new onsite wastewater systems shall not be issued where a wastewater treatment facility is accessible for connection.

300.2. Repairs to or replacement of failing onsite wastewater systems shall not be allowed where a wastewater treatment facility is accessible for connection.

301. Discharge of Waste.

No septic tank effluent or domestic wastewater or sewage shall be discharged to the surface of the ground or into any stream or body of water in South Carolina without an appropriate permit from the Department.

302. Changes in Use That Impact Existing Onsite Wastewater Systems.

If the use of a dwelling or facility is changed such that additions or alterations are proposed which increase wastewater flow, change wastewater characteristics, or compromise the integrity or function of the system, the onsite wastewater system shall be brought into full compliance with this regulation. Alterations that change the wastewater characteristics or increase wastewater flow will require the owner to submit an application and receive a permit to construct for the upgrade/expansion prior to any alterations.

400. Appendices of Standards for Permitted Systems.

Appendix A – System Standard 100/101 – Conventional with 14-Inch Aggregate Depth

(1) Site/Permitting Requirements

(a) The depth to the zone of saturation (ZOS) must be at least twenty-nine (29) inches below the naturally occurring soil surface and at least six (6) inches below the bottom of the proposed wastewater infiltration trenches at the deepest point of effluent application.

(b) The depth to any restrictive horizon must be greater than twelve (12) inches below the bottom of the proposed wastewater infiltration trenches at the deepest point of effluent application.

(c) The long-term acceptance rate for system sizing shall be based upon the most hydraulically limiting naturally occurring soil texture from the ground surface to twelve (12) inches below the bottom of the proposed wastewater infiltration trenches.

(d) There shall be a replacement area equivalent to at least fifty (50) percent in size of the original system area held in reserve for system repair. This area shall have a suitable configuration and shall meet the minimum soil and site conditions of this regulation.

(e) This system must not be used on sloping sites that require serial distribution unless it can be demonstrated that the entire wastewater infiltration trench installation (i.e., side wall to side wall and end to end) can meet the required textural limitations and the required offsets to the zone of saturation and restrictive horizons.

(2) Installation Requirements

(a) The wastewater infiltration trench aggregate shall be fourteen (14) inches in depth and shall be placed so as to provide seven (7) inches of aggregate below the pipe, four (4) inches beside the pipe, and three (3) inches above the pipe. The aggregate shall be covered with at least nine (9) inches of soil.

(b) The wastewater infiltration trench width shall be thirty-six (36) inches.

(c) Where gravity flow from the septic tank to the subsurface wastewater infiltration area is utilized, the invert elevation of the septic tank outlet shall be installed at an elevation at least equal to or higher than the top of the aggregate in the highest wastewater infiltration trench(es).

(d) All tree and brush removal shall be done in a manner that minimizes the disturbance or loss of naturally occurring soil.

(3) Final Landscaping and Drainage

(a) Installation of drainage swales, ditches, curtain drains, and rain gutters may be required to divert or intercept water away from the onsite wastewater system location to a positive outfall. The septic tank and subsurface wastewater infiltration area shall be backfilled and shaped to promote surface water runoff.

(b) A barrier to preclude parking and vehicular traffic over the system area may be required.

(c) Following final landscaping, seeding, or sodding may be required to prevent erosion.

(d) Final approval shall be withheld until all landscaping and drainage improvements have been satisfactorily completed.

**SOUTH CAROLINA DEPARTMENT OF HEALTH AND ENVIRONMENTAL CONTROL
BUREAU OF ENVIRONMENTAL HEALTH SERVICES**

CONVENTIONAL SYSTEM
WITH FOURTEEN (14) INCH AGGREGATE DEPTH

PROGRAM 360 / CODE 100 / CODE 101 IF PUJMPED

TYPICAL DESIGN ILLUSTRATION

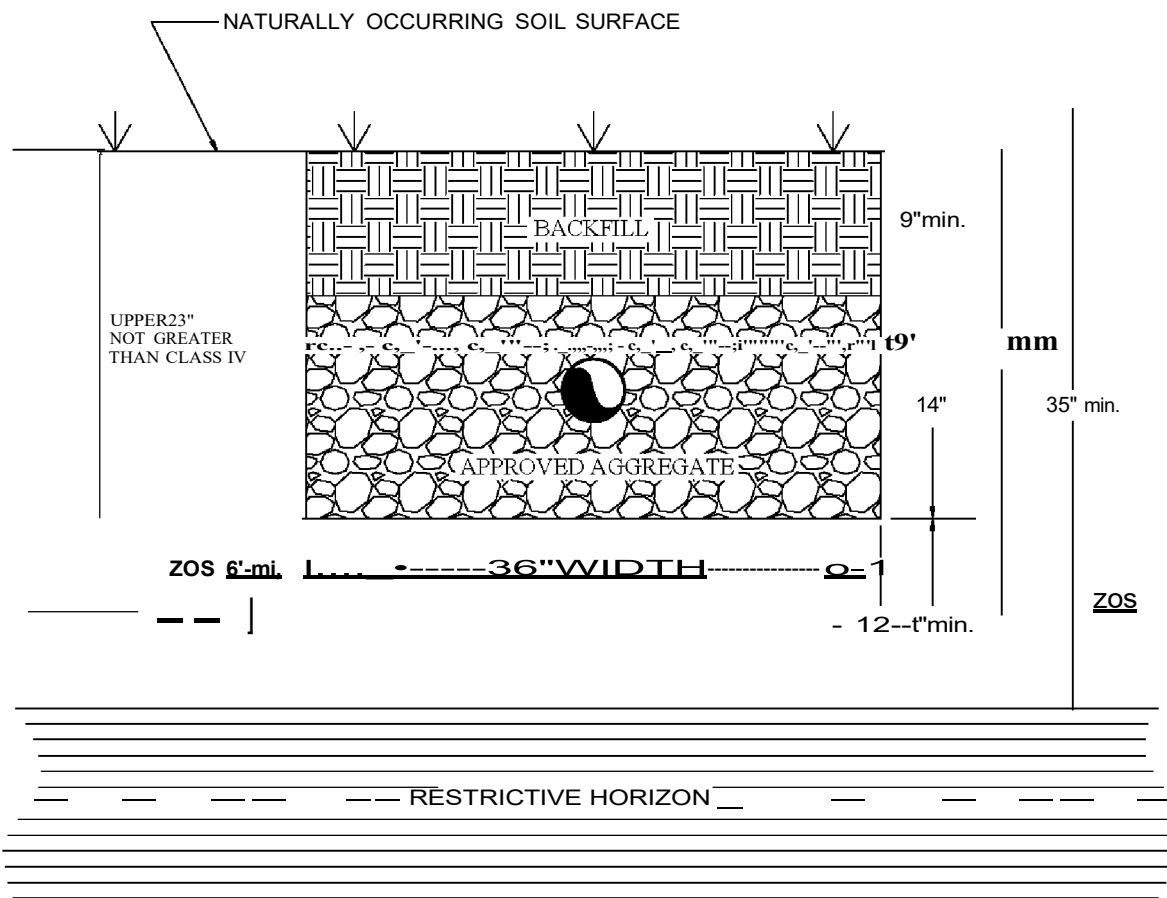

Rev. 10/19/2020

Appendix B – System Standard 150 – Large (greater than 1500 gpd) and Community Systems

(1) Site/Permitting Requirements

(a) Designs for large and community onsite wastewater systems shall be prepared by a Registered Professional Engineer licensed in South Carolina. Further, the Department may require whatever engineering and soils based submittals are deemed necessary to determine the feasibility and acceptability of any site for such a system.

(b) No part of the system, with the exception of solid pipe, may be located within one hundred (100) linear feet of a receptor.

(c) The depth to the zone of saturation (ZOS) shall be at least thirty-six (36) inches below the naturally occurring soil surface and at least six (6) inches below the deepest point of effluent application.

(d) The depth to any restrictive horizon must be greater than twelve (12) inches below the bottom of the proposed wastewater infiltration trenches.

(e) The long-term acceptance rate for system sizing shall be based upon the most hydraulically limiting, naturally occurring soil texture from the ground surface to twelve (12) inches below the bottom of the proposed wastewater infiltration trenches.

(f) There shall be at least fifty (50) percent reserved subsurface wastewater infiltration area repair or replacement area available consisting of soils suitable for a large onsite wastewater system, except where public (community) systems are utilized, in which case there must be at least one hundred (100) percent repair or replacement area.

(g) Large (greater than 1500 gpd) and community onsite wastewater systems incorporating advanced treatment methods, including but not limited to aerobic pre-treatment, lagoons, surface or subsurface drip irrigation, low pressure pipe distribution, and other maintenance intensive methods, shall be required to obtain a Land Application Permit under R.61-9.505.

(h) Efforts to circumvent the requirements of this standard by configuring remote, individually deeded, adjacently located subsurface wastewater infiltration areas in lieu of a community onsite wastewater system shall not be permitted. On a very limited basis, a few of these individual systems may be considered for mass installation where the wastewater infiltration trenches will be adjacent to each other in a defined area, provided that the combined peak wastewater loading is less than fifteen hundred (1500) gpd. In such cases:

(i) Each subsurface wastewater infiltration area plot shall be sized such that there is sufficient area for one hundred (100) percent subsurface wastewater infiltration area replacement.

(ii) Each plot shall be deeded with all appropriate easements as a lot in conjunction with the specific unit that it serves, and required protective offsets, as described in Section 200.6, shall apply to each individual remote subsurface wastewater infiltration area.

(iii) A plan shall be prepared by a Registered Professional Engineer licensed in South Carolina that illustrates the overall plan; specifies the route and identification of effluent sewers and force mains; specifies the entity responsible for perpetual maintenance of the sewer lines and mass subsurface wastewater infiltration area; specifies the configuration and identification of the individual subsurface

wastewater infiltration area parcels; and specifies the manner in which ingress and egress will be provided to the individual subsurface wastewater infiltration area parcels.

(iv) When the combined peak wastewater loading of the adjacently located subsurface wastewater infiltration areas from the entire project will exceed fifteen hundred (1500) gpd, the project shall be considered as a public (community) collection and treatment system, and all requirements described in Section 103.1(5) and this standard shall apply.

(2) Installation Requirements

(a) Large (greater than 1500 gpd) and community onsite wastewater systems shall not be constructed in fill material and shall not be placed any closer to receptors than one hundred (100) feet.

(b) Conventional wastewater infiltration trenches installed in the naturally occurring soil and having a width of thirty-six (36) inches shall be utilized.

(c) Wherever possible, designs that favor long wastewater infiltration trenches, convex landscape positions, and rectangular subsurface wastewater infiltration area configurations shall be required.

(d) All tree/brush removal shall be done in a manner that minimizes the disturbance or loss of naturally occurring soil.

(3) Community or Cluster Collection and Treatment Onsite Wastewater Systems

(a) An onsite wastewater system serving more than one (1) piece of deeded property shall be considered as a public (community) collection and treatment system.

(b) A permit activity will not occur that is inconsistent with a plan or plan amendment approved under Section 208(b) of the Clean Water Act, unless the Department finds such variance necessary to protect the public's health, safety, and welfare.

(c) A public entity shall own the system and shall be responsible for the operation, maintenance, and replacement of all components unless otherwise approved by the Department. The Department may consider a request from a private entity or person; however, such proposals must be evaluated on a case-by-case basis. The Department will evaluate the capability of long-term, reliable system operation in its evaluation of a permit request.

(d) If the project is owned by a private entity or person, the Department shall require financial assurances for the operation, maintenance, and replacement of the tank(s) and subsurface wastewater infiltration area system and relevant collection/pumping components.

(e) There shall be an area equivalent to one hundred (100) percent in size of the original primary subsurface wastewater infiltration area held in reserve for system repair or replacement. This area shall have a suitable configuration and shall meet all minimum requirements for large onsite wastewater systems.

(f) The collection sewer and pumping portions of a community onsite wastewater system shall receive a separate Construction Permit under R.61-67.300.

(g) The responsible party(s) on record shall be required to properly operate and maintain in good working order all system(s) parts which are installed pursuant to the permit and to comply with all terms

and conditions of the permit. System parts include, but are not limited to, sealed watertight tanks, lid(s), piping, aggregate, pump, and pump components.

Appendix C – System Standard 210/211 – Shallow Placement with 9-Inch Aggregate Depth

(1) Site/Permitting Requirements

(a) There must not be a zone of saturation (ZOS) within twenty-four (24) inches of the naturally occurring soil surface.

(b) The depth to any restrictive horizon must be greater than twelve (12) inches below the bottom of the proposed wastewater infiltration trenches.

(c) The texture in the upper eighteen (18) inches of naturally occurring soil may either be Class I, Class II, Class III, or Class IV.

(d) The long-term acceptance rate for system sizing shall be based upon the most hydraulically limiting naturally occurring soil texture from the ground surface to twelve (12) inches below the bottom of the proposed wastewater infiltration trenches.

(e) Due to the decreased sidewall absorption area and the increased potential for ground water mounding near the surface, the Equivalency Factors for these systems shall be calculated by conventional wastewater infiltration trenches and increased by an additional factor of 0.09 times.

(f) There shall be a replacement area equivalent to at least fifty (50) percent in size of the original system area held in reserve for system repair. This area shall have a suitable configuration and shall meet the minimum soil and site conditions of this regulation.

(g) This system must not be used on sloping sites that require serial distribution unless it can be demonstrated that the entire wastewater infiltration trench installation (i.e., side wall to side wall and end to end) can meet the required textural limitations and the required offsets to the zone of saturation and restrictive horizons.

(h) This system cannot be considered for facilities with peak flow rates in excess of fifteen hundred (1500) gpd.

(2) Installation Requirements

(a) The wastewater infiltration trench aggregate shall be nine (9) inches in depth and shall be covered with at least nine (9) inches of backfill.

(b) The wastewater infiltration trench width shall be thirty-six (36) inches.

(c) The maximum depth of the bottom of the wastewater infiltration trench shall be eighteen (18) inches below the naturally occurring soil surface unless it can be demonstrated that deeper placement can meet the required textural limitations and the offsets to the zone of saturation and restrictive horizons.

(d) Where gravity flow from the septic tank to the subsurface wastewater infiltration area is utilized, the invert elevation of the septic tank outlet shall be installed at an elevation at least equal to or higher than the top of the aggregate in the highest wastewater infiltration trench(es).

(e) All tree and brush removal shall be done in a manner that minimizes the disturbance or loss of naturally occurring soil.

(3) Final Landscaping and Drainage

(a) Installation of drainage swales, ditches, curtain drains, and rain gutters may be required to divert or intercept water away from the onsite wastewater system location to a positive outfall. The septic tank and subsurface wastewater infiltration area shall be backfilled and shaped to promote surface water runoff.

(b) A barrier to preclude parking and vehicular traffic over the system area may be required.

(c) Following final landscaping, seeding or sodding may be required to prevent erosion.

(d) Final approval shall be withheld until all landscaping and drainage improvements have been satisfactorily completed.

**SOUTH CAROLINA DEPARTMENT OF HEALTH AND ENVIRONMENTAL CONTROL
BUREAU OF ENVIRONMENTAL HEALTH**

ALTERNATIVE STANDARD
SHALLOW PLACEMENT WITH NINE (9) INCH AGGREGATE DEPTH

PROGRAM 362 / CODE 210 / CODE 211 IF PUMPED

TYPICAL DESIGN ILLUSTRATION

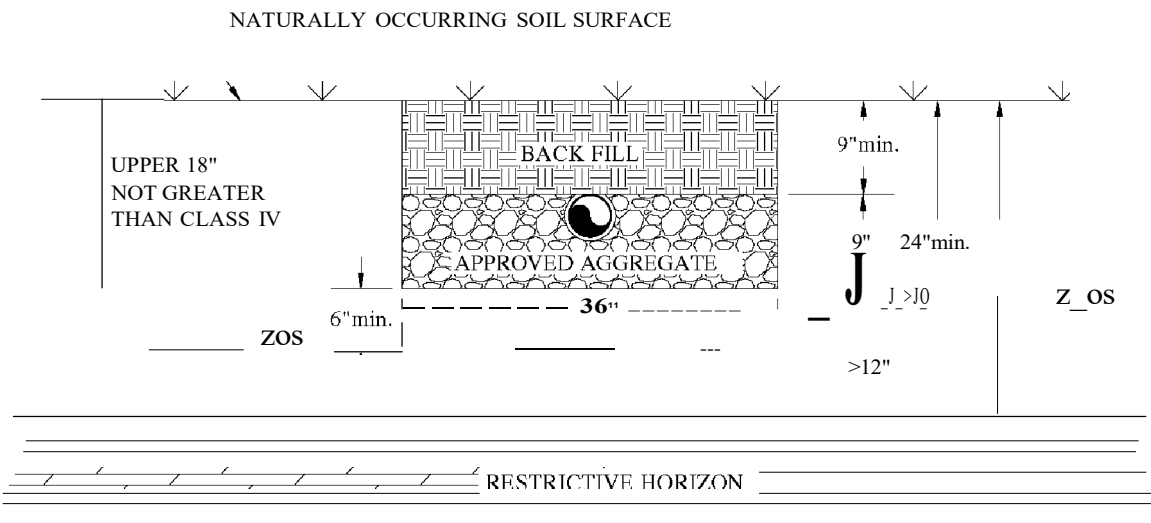

NOT TO SCALE

REV. 03/09/2018

Appendix D – System Standard 220/221 – Shallow Placement with Six (6)-Inch Aggregate Depth

(1) Site/Permitting Requirements

(a) There must not be a zone of saturation (ZOS) within twenty-one (21) inches of the naturally occurring soil surface.

(b) The depth to any restrictive horizon must be greater than twelve (12) inches below the bottom of the proposed wastewater infiltration trenches.

(c) The texture in the upper eighteen (18) inches of naturally occurring soil may either be Class I, Class II, Class III, or Class IV.

(d) The long-term acceptance rate for system sizing shall be based upon the most hydraulically limiting naturally occurring soil texture from the ground surface to twelve (12) inches below the bottom of the proposed wastewater infiltration trenches.

(e) Due to the decreased sidewall absorption area and the increased potential for ground water mounding near the surface, the Equivalency Factors for these systems shall be calculated by conventional wastewater infiltration trenches and increased by an additional factor of 0.12 times.

(f) There shall be a replacement area equivalent to at least fifty (50) percent in size of the original system area held in reserve for system repair. This area shall have a suitable configuration and shall meet the minimum soil and site conditions of this regulation.

(g) This system must not be used on sloping sites that require serial distribution unless it can be demonstrated that the entire wastewater infiltration trench installation (i.e., side wall to side wall and end to end) can meet the required textural limitations and the required offsets to the zone of saturation and restrictive horizons.

(h) This system cannot be considered for facilities with peak flow rates in excess of fifteen hundred (1500) gpd.

(2) Installation Requirements

(a) The wastewater infiltration trench aggregate shall be six (6) inches in depth and shall be covered with at least nine (9) inches of backfill.

(b) The wastewater infiltration trench width shall be thirty-six (36) inches.

(c) The maximum depth of the bottom of the wastewater infiltration trench shall be fifteen (15) inches below the naturally occurring soil surface unless it can be demonstrated that deeper placement can meet the required textural limitations and the offsets to the zone of saturation and restrictive horizons.

(d) Where gravity flow from the septic tank to the subsurface wastewater infiltration area is utilized, the invert elevation of the septic tank outlet shall be installed at an elevation at least equal to or higher than the top of the aggregate in the highest wastewater infiltration trench(es).

(e) All tree and brush removal shall be done in a manner that minimizes the disturbance or loss of naturally occurring soil.

(3) Final Landscaping and Drainage

(a) Installation of drainage swales, ditches, curtain drains, and rain gutters may be required to divert or intercept water away from the onsite wastewater system location to a positive outfall. The septic tank and subsurface wastewater infiltration area shall be backfilled and shaped to promote surface water runoff.

(b) A barrier to preclude parking and vehicular traffic over the system area may be required.

(c) Following final landscaping, seeding or sodding may be required to prevent erosion.

(d) Final approval shall be withheld until all landscaping and drainage improvements have been satisfactorily completed.

SOUTH CAROLINA DEPARTMENT OF HEALTH AND ENVIRONMENTAL CONTROL
 BUREAU OF ENVIRONMENTAL HEALTH SERVICES

A TERNAU STANDARD
 SHALL DWELL WITH SIX (6) INCH AGGREGATED PTH

PROGRAM 362/COD 220/COD -1 II <PUMPED

TECHNICAL DESIGNATION

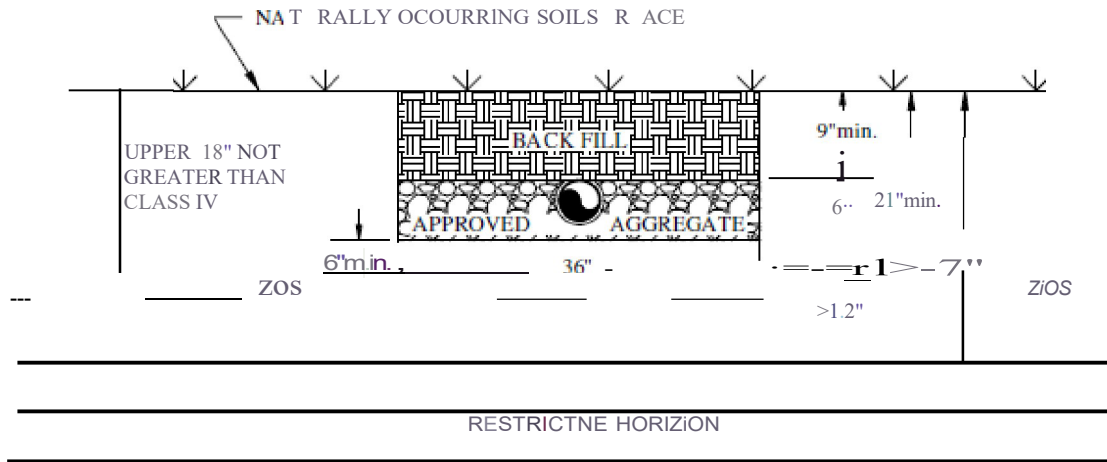

NOT TO SCALE

Rev. 03/09/18

Appendix E – System Standard 230/231 – Shallow Placement with 14-Inch Aggregate Depth with Fill Cap

(1) Site/Permitting Requirements

(a) There must not be a zone of saturation (ZOS) within twenty (20) inches of the naturally occurring soil surface.

(b) The depth to any restrictive horizon must be greater than twelve (12) inches below the bottom of the proposed wastewater infiltration trenches.

(c) The texture in the upper eighteen (18) inches of naturally occurring soil must be no more limiting than Class III.

(d) This system must not be used on sloping sites that require serial distribution unless it can be demonstrated that the entire wastewater infiltration trench installation (i.e., side wall to side wall and end to end) can meet the required textural limitations and the required offsets to the zone of saturation and restrictive horizons.

(e) The long-term acceptance rate for system sizing shall be based upon the most hydraulically limiting naturally occurring soil texture from the ground surface to twelve (12) inches below the bottom of the proposed wastewater infiltration trenches.

(f) The total linear footage of wastewater infiltration trenches shall be the same as that required for conventional systems.

(g) There shall be a replacement area equivalent to at least fifty (50) percent in size of the original system area held in reserve for system repair. This area shall have a suitable configuration and shall meet the minimum soil and site conditions of this regulation.

(h) This system cannot be considered for facilities with peak flow rates in excess of fifteen hundred (1500) gpd.

(2) Installation Requirements

(a) The wastewater infiltration trench width shall be thirty-six (36) inches.

(b) The maximum depth of the bottom of the wastewater infiltration trench shall be fourteen (14) inches below the naturally occurring soil surface unless it can be demonstrated that deeper placement can meet the required textural limitations and the offsets to the zone of saturation and restrictive horizons.

(c) The depth of the fill cap shall provide a minimum of twelve (12) inches of soil cover above the top of the wastewater infiltration trench aggregate.

(d) Where gravity flow from the septic tank to the subsurface wastewater infiltration area is utilized, the invert elevation of the septic tank outlet shall be installed at an elevation at least equal to or higher than the top of the aggregate in the highest wastewater infiltration trench(es).

(e) The required fill cap must extend at least five (5) feet beyond the limits of the subsurface wastewater infiltration trenches and must taper to the original soil surface at a slope not to exceed 10 percent. On sloping sites, where serial distribution has been incorporated into the system design, on the

lower side and ends of the wastewater infiltration trenches, the fill cap must extend to at least ten (10) feet beyond the limits of the wastewater infiltration trenches and must taper to the original soil surface at a slope not to exceed five (5) percent. The required property line setback shall be measured from the point at which the fill cap taper intersects with the natural soil surface. The fill cap must be installed prior to beginning trench installation when required on the construction permit.

(f) The required fill material must be soil texture Class I, Class II, or Class III and be devoid of extraneous debris such as organic matter, building materials, etc.

(g) The wastewater infiltration trench aggregate shall be fourteen (14) inches in depth.

(h) All tree/brush removal shall be done in a manner that minimizes the disturbance or loss of naturally occurring soil.

(3) Final Landscaping and Drainage

(a) The septic tank and fill cap area shall be backfilled and shaped to promote the runoff of surface water.

(b) Where natural surface drainage does not exist, a swale shall be constructed adjacent to the fill cap area to divert surface water away from the onsite wastewater system to a positive outfall. The installation of ditches, curtain drains, and rain gutters may be required to intercept and divert water away from the onsite wastewater system location.

(c) A barrier to preclude parking and vehicular traffic over the system area may be required.

(d) Following final landscaping, seeding or sodding may be required to prevent erosion.

(e) Final approval shall be withheld until all landscaping and drainage improvements have been satisfactorily completed.

OUTH CAROLI DEPARTMENT OF HEALTH DEPARTMENT OF ENVIRONMENTAL CONTROL
 BUREAU OF ENVIRONMENTAL HEALTH SERVICES

ALTERNATIVE STANDARD
 SHALLOW PLACEMENT SYSTEM WITH FILL CAI'

PROGRAM 362 / COD 2.30 / CUDE 231(E) / MPED

TYPICAL DESIGN ILLUSTRATION

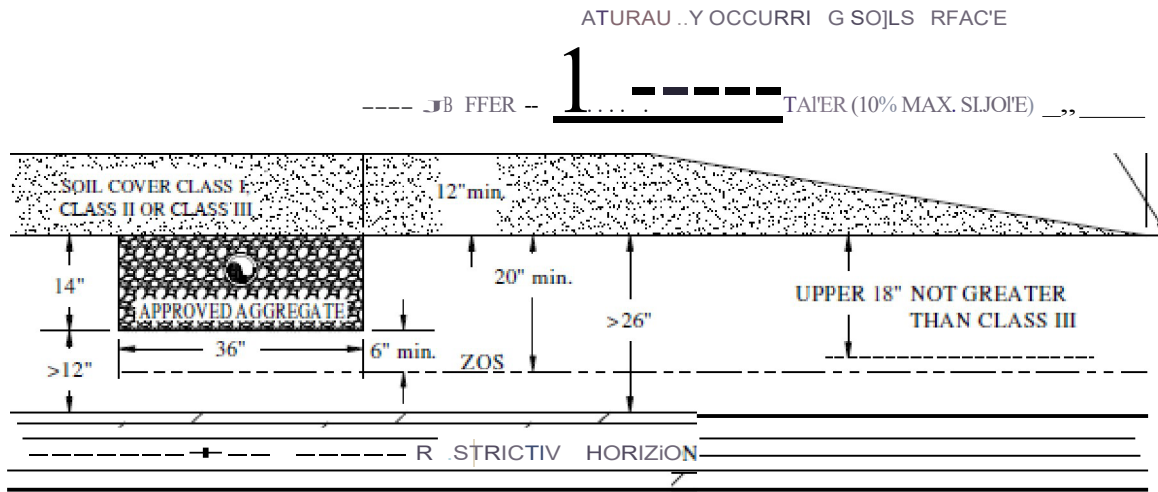

SCALE

Rev. 03/09/18

Appendix F – System Standard 240/241 – Ultra-Shallow Placement with 6-Inch Aggregate Depth with Fill Cap

(1) Site/Permitting Requirements

(a) There must not be a zone of saturation (ZOS) within twelve (12) inches of the naturally occurring soil surface.

(b) The depth to any restrictive horizon must be greater than twelve (12) inches below the bottom of the proposed wastewater infiltration trenches.

(c) The soil texture in the upper eighteen (18) inches of naturally occurring soil must be no more limiting than Class III.

(d) This system must not be used on sloping sites that require serial distribution unless it can be demonstrated that the entire wastewater infiltration trench installation (i.e., side wall to side wall and end to end) meets the required textural limitations and required offsets to the zone of saturation and restrictive horizons.

(e) No part of this system can be installed within one hundred twenty-five (125) feet of the critical area line or tidal waters as determined by the Department; or within one hundred twenty-five (125) feet of the ordinary high water elevation within the banks of non-tidal, environmentally sensitive waters.

(f) The long-term acceptance rate for system sizing shall be based upon the most hydraulically limiting naturally occurring soil texture from the ground surface to twelve (12) inches below the bottom of the proposed wastewater infiltration trenches.

(g) Due to the decreased sidewall area and the increased potential for ground water mounding near the surface, the Equivalency Factors for these systems shall be calculated by conventional wastewater infiltration trenches and increased by an additional factor of 0.12 times.

(h) There shall be a replacement area equivalent to at least fifty (50) percent in size of the original system area held in reserve for system repair. This area shall have a suitable configuration and shall meet the minimum soil and site conditions of this regulation.

(i) This system cannot be considered for facilities with peak flow rates in excess of fifteen hundred (1500) gpd.

(2) Installation Requirements

(a) The wastewater infiltration trench width shall be thirty-six (36) inches.

(b) The maximum depth of the bottom of the wastewater infiltration trench shall be six (6) inches below the naturally occurring soil surface unless it can be demonstrated that deeper placement can meet the required textural limitations and offsets to the zone of saturation and restrictive horizons.

(c) The depth of the fill cap shall provide a minimum of twelve (12) inches backfill above the top of the wastewater infiltration trench aggregate.

(d) Where gravity flow from the septic tank to the subsurface wastewater infiltration area is utilized, the invert elevation of the septic tank outlet shall be installed at an elevation at least equal to or higher than the top of the aggregate in the highest wastewater infiltration trench(es).

(e) The required fill cap must extend at least five (5) feet beyond the limits of the subsurface wastewater infiltration trenches and must taper to the original soil surface at a slope not to exceed 10 percent. On sloping sites where serial distribution has been incorporated into the system design, on the lower side and ends of the wastewater infiltration trenches, the fill cap must extend to at least ten (10) feet beyond the limits of the wastewater infiltration trenches and must taper to the original soil surface at a slope not to exceed five (5) percent. The required property line setback shall be measured from the point at which the fill cap taper intersects with the natural soil surface. The fill cap must be installed prior to beginning trench installation when required on the construction permit.

(f) The required fill material must be soil texture Class I, Class II, or Class III, and be devoid of extraneous debris such as organic matter, building materials, etc.

(g) The wastewater infiltration trench aggregate shall be six (6) inches in depth.

(h) All tree/brush removal shall be done in a manner that minimizes the disturbance or loss of naturally occurring soil.

(3) Final Landscaping and Drainage

(a) The septic tank and fill cap area shall be backfilled and shaped to promote the runoff of surface water.

(b) Where natural surface drainage does not exist, a swale shall be constructed adjacent to the fill cap area to divert surface water away from the onsite wastewater system to a positive outfall. The installation of ditches, curtain drains, and rain gutters may be required to intercept and divert water away from the onsite wastewater system location.

(c) A barrier to preclude parking and vehicular traffic over the system area may be required.

(d) Following final landscaping, seeding or sodding may be required to prevent erosion.

(e) Final approval shall be withheld until all landscaping and drainage improvements have been satisfactorily completed.

STATE OF NORTH CAROLINA DEPARTMENT OF HEALTH AND HUMAN SERVICES
 DIVISION OF ENVIRONMENTAL HEALTH SERVICES

ALTERNATIVE STANDARD
 ULTRA-SHALLOW PLACEMENT SYSTEM WITH FILL CAP

PROGRAM 16-1 COD 240 (C) DE 241 IF 11 MPED

TYPE I LULUSIGNILL STR TION

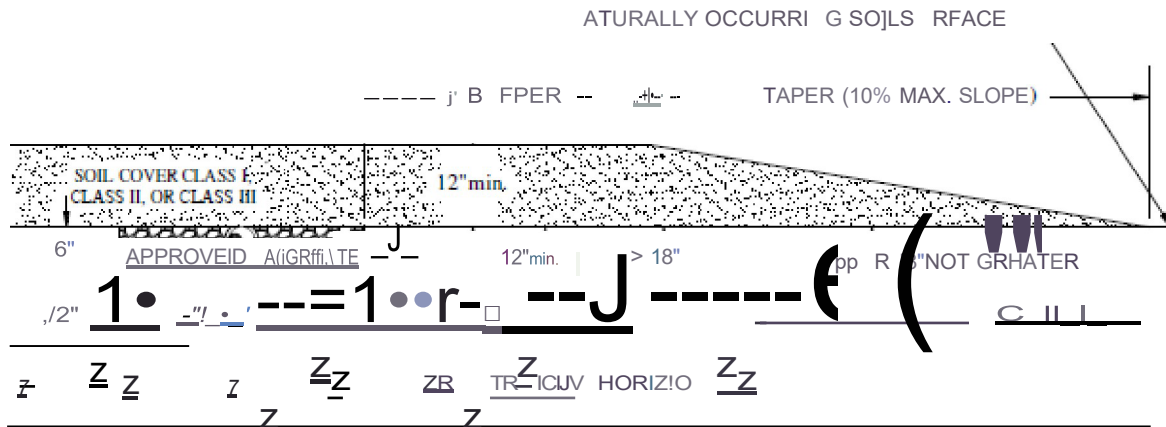

Rev. 03/09/18

Appendix G – System Standard 250/251 – Reservoir Infiltration System for Soils with Expansive Clay

(1) Site/Permitting Requirements

- (a) Rock formations must be greater than four (4) feet below the naturally occurring soil surface.
- (b) For standard installations (see Typical Design Illustration A), the wastewater infiltration trenches must penetrate the saprolite at least six (6) inches. There must be an offset greater than twelve (12) inches between the bottom of the trenches and any rock formations. (i.e., there must be greater than eighteen (18) inches of clean, unconsolidated saprolite below the expansive clay layer.)
- (c) If the unconsolidated saprolite layer is greater than sixty (60) inches below the naturally occurring soil surface (see Typical Design Illustration B), paragraph (1)(b) (above) shall apply and clean medium sand shall be added to the trenches so that the top of the aggregate will be twelve (12) inches below finished grade.
- (d) There must be no evidence of a zone of saturation (ZOS) in the unconsolidated saprolite layer.
- (e) The long-term acceptance rate shall not exceed 0.25 gpd/sq. ft.
- (f) There shall be a replacement area equivalent to at least fifty (50) percent in size of the original system area held in reserve for system repair. This area shall have a suitable configuration and shall meet the minimum soil and site conditions of this regulation.
- (g) Sites to be considered for this system shall be evaluated using backhoe pits to describe the soil profile.
- (h) This system cannot be considered for facilities with peak flow rates in excess of fifteen hundred (1500) gpd.
- (i) Clean, unconsolidated saprolite shall be defined as soft, friable, thoroughly decomposed rock that has formed in place by chemical weathering, retaining the fabric and structure of the parent rock, and being devoid of expansive clay. Unconsolidated saprolite can be dug using a hand auger or knife. Consolidated saprolite cannot be penetrated with a hand auger or similar tool and must be dug with a backhoe or other powered equipment.
- (ii) Expansive clay shall be defined as soils containing significant amounts of expansible-layer clay minerals or smectites as evidenced in the field by classifications of Very Sticky and Very Plastic and Structure Grades of Weak or Structureless when evaluated in accordance with the Field Book. Such soils are considered to be unsuitable for onsite wastewater systems.

(2) Installation Requirements

- (a) The depth of approved aggregate shall be twenty-four (24) inches.
- (b) The depth of medium sand will vary between zero (0) and one hundred twenty (120) inches, depending upon the depth to the saprolite layer.
- (c) The trench width shall be thirty-six (36) inches.

(d) Where gravity flow from the septic tank to the subsurface wastewater infiltration area is utilized, the invert elevation of the septic tank outlet shall be installed at an elevation at least equal to or higher than the top of the aggregate in the highest wastewater infiltration trench(es).

(e) The backfill shall range from twelve (12) inches to thirty-six (36) inches for standard installations (see Typical Design Illustration A) and shall be twelve (12) inches where the depth to saprolite is greater than sixty (60) inches below the naturally occurring soil surface (see Typical Design Illustration B).

(3) Final Landscaping and Drainage

(a) On sites where there is evidence of a zone of saturation at the soil-expansive clay interface, a curtain drain must be placed upslope along a contour and must extend the entire length of the subsurface wastewater infiltration area. The curtain drain shall extend a minimum of six (6) inches into the expansive clay layer. The septic tank and subsurface wastewater infiltration area shall be backfilled and shaped to promote surface water runoff.

(b) Following final landscaping, seeding or sodding may be required to prevent erosion.

(c) Final approval shall be withheld until all landscaping and drainage improvements have been satisfactorily completed.

**SOUTH CAROLINA DEPARTMENT OF HEALTH AND ENVIRONMENTAL CONTROL
BUREAU OF ENVIRONMENTAL HEALTH SERVICES**

ALTERNATIVE SYSTEM
RESERVOIR INFILTRATION SYSTEM FOR SOILS WITH EXPANSIVE CLAY

PROGRAM 362 / CODE 250 / CODE 251 IF PUMPED

**TYPICAL DESIGN ILLUSTRATION (A)
STANDARD INSTALLATION**

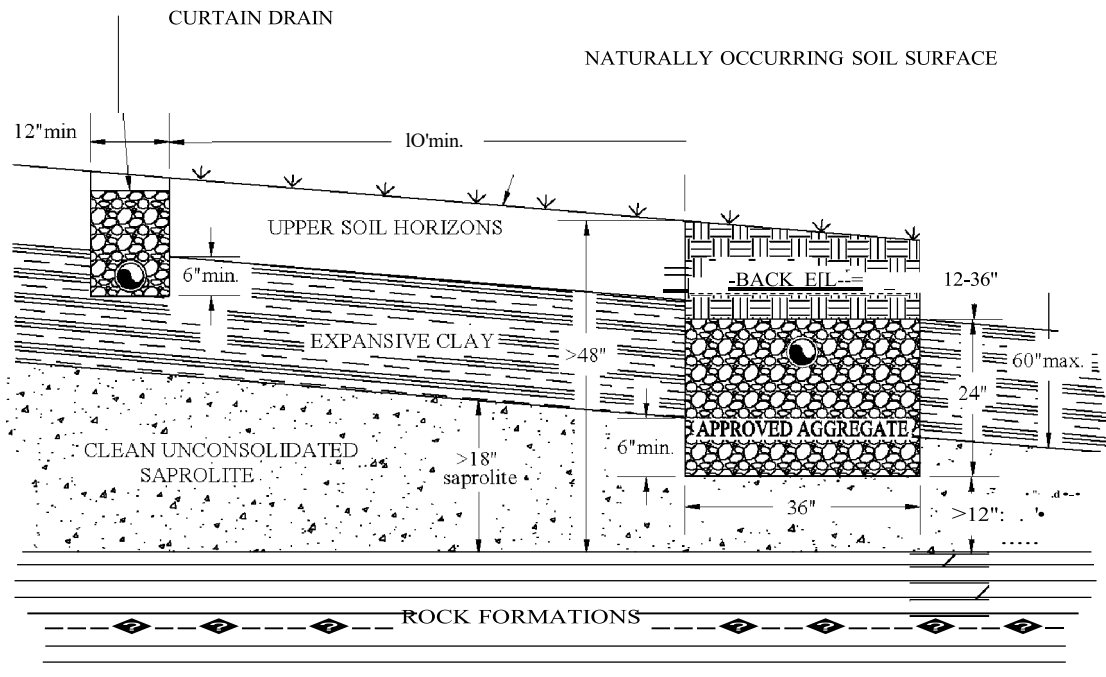

NOTE FOR SOILS WITH THICK EXPANSIVE CLAY HORIZONS
(i.e., DEPTH TO SAPROLITE > 60 INCHES BELOW NATURALLY OCCURRING SOIL SURFACE)
SEE TYPICAL DESIGN ILLUSTRATION (B)

NOT TO SCALE
REV. 03/09/18

**SOUTH CAROLINA DEPARTMENT OF HEALTH AND ENVIRONMENTAL CONTROL
BUREAU OF ENVIRONMENTAL HEALTH SERVICES**

ALTERNATIVE SYSTEM
RESERVOIR INFILTRATION SYSTEM FOR SOILS WITH EXPANSIVE CLAY

PROGRAM 362 / CODE 250 / CODE 251 IF PUMPED

**TYPICAL DESIGN ILLUSTRATION (B)
WHERE DEPTH TO SAPROLITE > 60in. BELOW SURFACE**

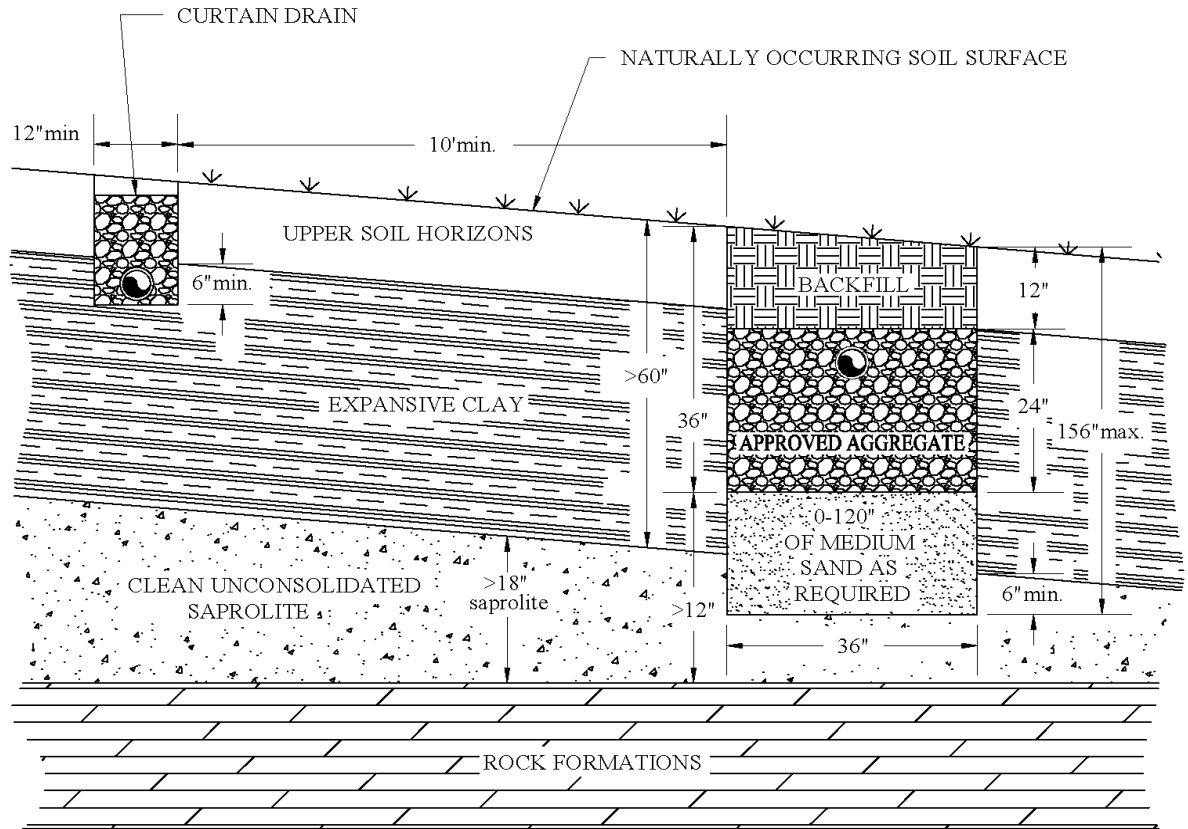

NOTE: FOR SOILS WITH THINNER EXPANSIVE CLAY HORIZONS
(i.e., DEPTH TO SAPROLITE NOT >60in. BELOW NATURALLY OCCURRING SOIL SURFACE)
SEE TYPICAL DESIGN ILLUSTRATION (A)

NOT TO SCALE

REV.03/09/18

Appendix H – System Standard 260/261 – 9-Inch Shallow Placement System with Fill Cap

(1) Site/Permitting Requirements

(a) There must not be a zone of saturation (ZOS) within fifteen (15) inches of the naturally occurring soil surface.

(b) The depth to any restrictive horizon must be greater than twelve (12) inches below the bottom of the proposed wastewater infiltration trenches.

(c) The texture in the upper eighteen (18) inches of naturally occurring soil must be no more limiting than Class III.

(d) This system must not be used on sloping sites that require serial distribution unless it can be demonstrated that the entire wastewater infiltration trench installation (i.e., side wall to side wall and end to end) can meet the required textural limitations and the required offsets to the zone of saturation and restrictive horizons.

(e) The long-term acceptance rate for system sizing shall be based upon the most hydraulically limiting naturally occurring soil texture from the ground surface to twelve (12) inches below the bottom of the proposed wastewater infiltration trenches.

(f) Due to the decreased sidewall absorption area and the increased potential for ground water mounding near the surface, the Equivalency Factors for these systems shall be calculated by conventional wastewater infiltration trenches and increased by an additional factor of 0.09 times.

(g) No part of this system can be installed within 125 feet of the critical area line or tidal waters as determined by the Department; or within 125 feet of the ordinary high water elevation within the banks of non-tidal, environmentally sensitive waters.

(h) There shall be a replacement area equivalent to at least fifty (50) percent in size of the original system area held in reserve for system repair. This area shall have a suitable configuration and shall meet the minimum soil and site conditions of this regulation.

(i) This system cannot be considered for facilities with peak flow rates in excess of fifteen hundred (1500) gpd.

(2) Installation Requirements

(a) The wastewater infiltration trench width shall be thirty-six (36) inches.

(b) The maximum depth of the bottom of the wastewater infiltration trench shall be nine (9) inches below the naturally occurring soil surface unless it can be demonstrated that deeper placement can meet the required textural limitations and the offsets to the zone of saturation and restrictive horizons.

(c) Where gravity flow from the septic tank to the subsurface wastewater infiltration area is utilized, the invert elevation of the septic tank outlet shall be installed at an elevation at least equal to or higher than the top of the aggregate in the highest wastewater infiltration trench(es).

(d) The depth of the fill cap shall provide a minimum of twelve (12) inches backfill above the top of the wastewater infiltration trench aggregate.

(e) The required fill cap must extend at least five (5) feet beyond the limits of the wastewater infiltration trenches and must taper to the original soil surface at a slope not to exceed 10 percent (see attached illustration). On sloping sites where serial distribution has been incorporated into the system design, on the lower side and ends of the wastewater infiltration trenches, the fill cap must extend to at least ten (10) feet beyond the limits of the wastewater infiltration trenches and must taper to the original soil surface at a slope not to exceed five (5) percent. The required property line setback shall be measured from the point at which the fill cap taper intersects with the naturally occurring soil surface. The fill cap must be installed prior to beginning trench installation when required on the construction permit.

(f) The required fill material must be soil texture Class I, Class II, or Class III, and be devoid of extraneous debris such as organic matter, building materials, etc.

(g) The wastewater infiltration trench aggregate shall be nine (9) inches in depth.

(h) All trees/brush removal shall be done in a manner that minimizes the disturbance or loss of naturally occurring soil.

(3) Final Landscaping and Drainage

(a) The septic tank and fill cap area shall be backfilled and shaped to promote the runoff of surface water.

(b) Where natural surface drainage does not exist, a swale shall be constructed adjacent to the fill cap area to divert surface water away from the onsite wastewater system to a positive outfall. The installation of ditches, curtain drains, and rain gutters may be required to intercept and divert water away from the onsite wastewater system location.

(c) A barrier to preclude parking and vehicular traffic over the system area may be required.

(d) Following final landscaping, seeding or sodding may be required to prevent erosion.

(e) Final approval shall be withheld until all landscaping and drainage improvements have been satisfactorily completed.

NORTH CAROLINA DEPARTMENT OF HEALTH AND ENVIRONMENT CONTROL
 BUREAU OF ENVIRONMENTAL HEALTH SERVICES

ALTERNATIVE STANDARD
 ONE INCH SHALLOW PORTLAND CEMENT JAIL-FILL CAP
 PROGRAM 16 F.COD. 260 f. CODE 261 F.P. MPED

TYPICAL DESIGN ILLUSTRATION

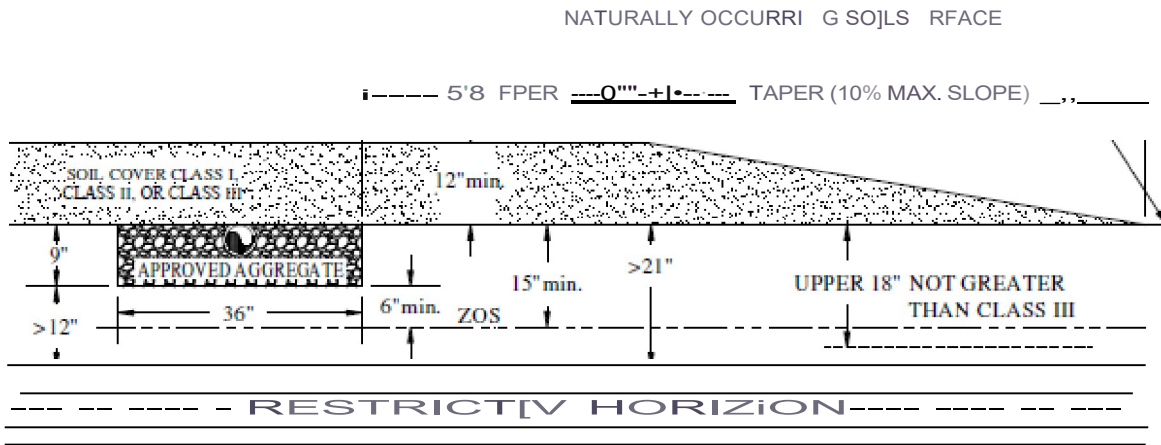

OTTO SCALI

Rev. 03/09/18

Appendix I – System Standard 270/271 – Alternative Trench Width and Depth Systems

(1) Site/Permitting Requirements

(a) Soil conditions, the depth to rock and other restrictive horizons, the depth to the zone of saturation (ZOS), and the elevation differential between the septic tank outlet and the highest wastewater infiltration trench(es) must meet applicable standards for conventional or alternative onsite wastewater systems.

(b) There shall be a replacement area equivalent to at least fifty (50) percent in size of the original system area held in reserve for system repair. This area shall have a suitable configuration and shall meet the minimum soil and site conditions of this regulation.

(c) This system cannot be considered for facilities with peak flow rates in excess of fifteen hundred (1500) gpd unless the trench width is three (3) feet and the aggregate depth is between fourteen (14) and twenty-eight (28) inches.

(d) The linear footage requirement for an alternative width and depth system shall be determined by first figuring the conventional (thirty-six (36) inch wide with fourteen (14) inch aggregate depth) linear footage requirements and then multiplying by the appropriate factor based on desired trench width and aggregate depth. (See table below system illustration for multiplication factors.)

(2) Installation Requirements

(a) Trench widths shall not exceed ten (10) feet.

(b) The aggregate depth shall be between six (6) inches and twenty-eight (28) inches when considering trench widths ranging from one and one-half (1½) to ten (10) feet (see chart). The aggregate depth may be increased to a maximum of forty-two (42) inches, provided the trench width does not exceed thirty-six (36) inches (Note: In these cases, the equivalency formula should be utilized to determine the appropriate factor (F) when considering aggregate depths between twenty-eight (28) and forty-two (42) inches). All trenches shall be covered with at least nine (9) inches of backfill.

(c) Methods of construction which preclude vehicular compaction of the trench bottom must always be utilized.

(3) Final Landscaping and Drainage

(a) Installation of drainage swales, ditches, diversion drains, or rain gutters may be required to divert or intercept water away from the onsite wastewater system location. The septic tank and subsurface wastewater infiltration area shall be backfilled and shaped to promote surface water runoff.

(b) A barrier to preclude parking and vehicular traffic over the area of the system may be required.

(c) Following final landscaping, seeding or sodding may be required to prevent erosion.

(d) Final approval shall be withheld until all landscaping and drainage improvements have been satisfactorily completed.

**SOUTH CAROLINA DEPARTMENT OF HEALTH AND ENVIRONMENTAL CONTROL
BUREAU OF ENVIRONMENTAL HEALTH SERVICES**

ALTERNATIVE STANDARD
ALTERNATIVE TRENCH WIDTH & DEPTH SYSTEMS

PROGRAM 362 / CODE 270 / CODE 271 IF PUMPED

TYPICAL DESIGN ILLUSTRATION

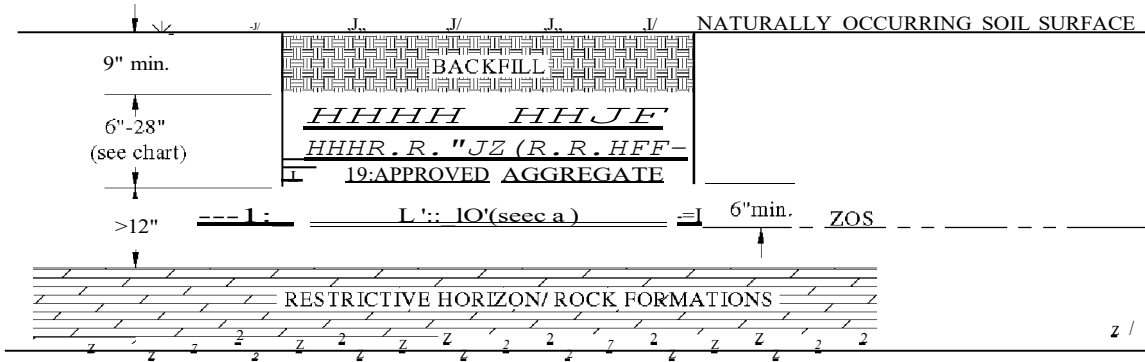

NOT TO SCALE

FACTORS (F) FOR MAINTAINING EQUIVALENT INFILTRATIVE SURFACE AREA

TRENCH WIDTH (ft.)	AGGREGATE DEPTH (in.)					
	6" *	9" **	14"	20"	24"	28"
1.5'	2.39	1.94	USE LIAR STANDRARD	1.10	0.97	0.87
2.0'	1.99	1.66	USE LIAR STANDRARD	1.00	0.89	0.80
2.5'	1.71	1.46	USE LIAR STANDRARD	0.91	0.82	0.75
3.0'	1.50	1.30	USE LIAR STANDRARD	0.84	0.76	0.70 <small>see system 360/380</small>
4.0'	1.20	1.06	0.84	0.73	0.67	0.62
5.0'	1.00	0.89	0.73	0.64	0.59	0.55
6.0'	0.85	0.78	0.64	0.57	0.53	0.50
7.0'	0.74	0.68	0.57	0.52	0.49	0.46
8.0'	0.66	0.61	0.52	0.47	0.45	0.42
9.0'	0.59	0.55	0.47	0.43	0.41	0.39
10.0'	0.54	0.51	0.43	0.40	0.38	0.36

$$F = \frac{5.33 \text{ sqft. / ft}}{2 (\text{SwD} / 12) + \text{TW}}$$

* Factors (F) reflect 12% increase
** Factors (F) reflect 9% increase
(See notes in text)

Where, 5.33 sqft/ft = total infiltrative surface area per linear foot of conventional type trench (36in. wide, 14in. deep)

SwD = Side Wall Depth (in)
TW = Trench Width (ft.)

REV. 03/09/2018

Appendix J – System Standard 280/281 – Reservoir Infiltration System for Soils with Expansive Clay Shallow Rock Formations

(1) Site/Permitting Requirements

(a) Rock formations must be rippable to a depth greater than four (4) feet below the naturally occurring soil surface.

(b) The soil wastewater infiltration trenches must penetrate the saprolite at least six (6) inches, and there must be an offset greater than twelve (12) inches between the trench bottoms and any rock formations (i.e., there must be at least six (6) inches of clean, unconsolidated saprolite below the expansive clay layer, and medium sand may be added to the excavation to achieve an offset from rock that exceeds twelve (12) inches).

(c) There must be no evidence of a zone of saturation (ZOS) in the unconsolidated saprolite layer.

(d) The long-term acceptance rate shall not exceed 0.20-gpd/sqft.

(e) Effluent discharged to this system must receive a higher degree of treatment than that provided by a conventional septic tank (e.g., two (2) compartment septic tank or two (2) septic tanks in series).

(f) There shall be a replacement area equivalent to at least fifty (50) percent in size of the original system area held in reserve for system repair. This area shall have a suitable configuration and shall meet the minimum soil and site conditions of this regulation.

(g) No part of this system can be installed within one hundred twenty-five (125) feet of the ordinary high water elevation within the banks of environmentally sensitive waters.

(h) Sites to be considered for this system shall be evaluated using backhoe pits to describe the soil profile.

(i) This system cannot be considered for facilities with peak flow rates in excess of fifteen hundred (1500) gpd.

(i) Clean, unconsolidated saprolite shall be defined as soft, friable, thoroughly decomposed rock that has formed in place by chemical weathering, retaining the fabric and structure of the parent rock, and being devoid of expansive clay. Unconsolidated saprolite can be dug using a hand auger or knife. Consolidated saprolite cannot be penetrated with a hand auger or similar tool, and must be dug with a backhoe or other powered equipment.

(ii) Expansive clay shall be defined as soils containing significant amounts of expansible-layer clay minerals (smectites) as evidenced in the field by classifications of Very Sticky and Very Plastic and Structure Grades of Weak or Structureless when evaluated in accordance with the Field Books. Such soils are considered to be unsuitable for onsite wastewater systems.

(2) Installation Requirements

(a) The depth of approved aggregate shall be at least twenty-four (24) inches.

(b) The trench width shall be thirty-six (36) inches.

(c) Where gravity flow from the septic tank to the subsurface wastewater infiltration area is utilized, the invert elevation of the septic tank outlet shall be installed at an elevation at least equal to or higher than the top of the aggregate in the highest wastewater infiltration trench(es).

(3) Final Landscaping and Drainage

(a) On sites where there is evidence of a zone of saturation at the soil-expansive clay interface, a curtain drain must be placed upslope along a contour and must extend the entire length of the subsurface wastewater infiltration area. The curtain drain shall extend a minimum of six (6) inches into the expansive clay layer. The septic tank and subsurface wastewater infiltration area shall be backfilled and shaped to promote surface water runoff.

(b) Final approval shall be withheld until all landscaping, drainage, and other requirements have been satisfactorily completed.

(c) Following final landscaping, seeding or sodding may be required to prevent erosion.

(d) Final approval shall be withheld until all landscaping and drainage improvements have been satisfactorily completed.

**SOUTH CAROLINA DEPARTMENT OF HEALTH AND ENVIRONMENTAL CONTROL
BUREAU OF ENVIRONMENTAL HEALTH SERVICES**

ALTERNATIVE SYSTEM
RESERVOIR INFILTRATION SYSTEM FOR SOILS WITH EXPANSIVE CLAY
OVER SHALLOW ROCK FORMATIONS

PROGRAM 362 / CODE 280 / CODE 281 IF PUMPED

TYPICAL DESIGN ILLUSTRATION

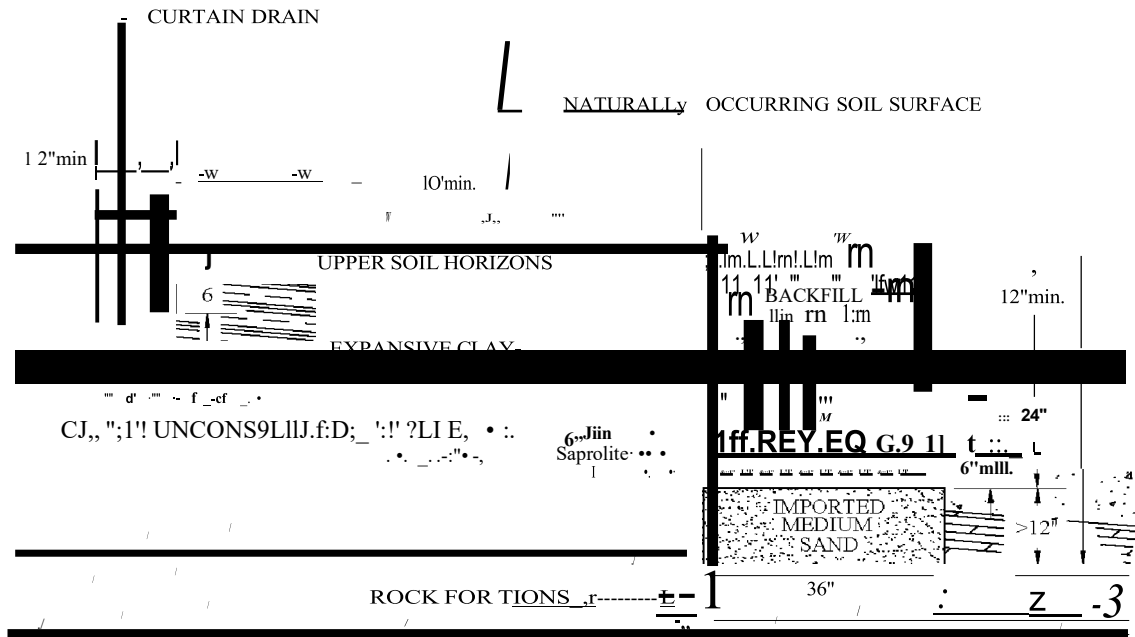

NOT TO SCALE
REV. 03/09/19

Appendix K – System Standard 290/291 – Alternative Trench Width and Depth Systems with Fill Cap

(1) Site/Permitting Requirements

(a) The depth to any restrictive horizon must be greater than twelve (12) inches below the bottom of the proposed wastewater infiltration trenches.

(b) The texture in the upper eighteen (18) inches of naturally occurring soil must be no more limiting than Class III.

(c) Soil conditions, the depth to rock and other restrictive horizons, the depth to the zone of saturation (ZOS), and the elevation differential between the septic tank outlet and the highest wastewater infiltration trench(es) must meet applicable standards for alternative onsite wastewater systems.

(d) There shall be a replacement area equivalent to at least fifty (50) percent in size of the original system area held in reserve for system repair. This area shall have a suitable configuration and shall meet the minimum soil and site conditions of this regulation.

(e) This system cannot be considered for facilities with peak flow rates in excess of six hundred (600) gpd.

(f) The linear footage requirement for an alternative width and depth system shall be determined by first figuring the conventional (36-inch-wide with 14-inch aggregate depth) linear footage requirements and then multiplying by the appropriate factor based on desired trench width and aggregate depth as computed in the following table:

FACTOR (F) FOR MAINTAINING EQUIVALENT INFILTRATIVE SURFACE AREA			
TRENCH WIDTH (ft.)	AGGREGATE DEPTH (in.)		
	6" *	9" **	# OF DISTRIBUTION PIPES
	MULTIPLICATION FACTOR		
4'	1.20	1.06	1
5'	1.00	0.89	1
6'	0.85	0.78	2
7'	0.74	0.68	2
8'	0.66	0.61	2
9'	0.59	0.55	3
10'	0.54	0.51	3
* Factors reflect a twelve (12) percent increase ** Factors reflect a nine (9) percent increase			

(g) This system may only be installed on sites where the long-term acceptance rate (LTAR) for the system will be between 1.0 and 0.5 gpd per foot squared (gpd/ft²). The bottom of the absorption field cannot be installed in Class IV soils (0.4 to 0.1 LTAR).

(h) The distribution pipes in the bed shall be at least eighteen (18) inches from the edge of the trench and located on three (3) foot centers.

(i) This system must not be used on sloping sites that require serial distribution unless it can be demonstrated that the entire wastewater infiltration trench installation (i.e., side wall to side wall and end to end) can meet the required textural limitations and the required offsets to the zone of saturation and restrictive horizons.

(j) The long-term acceptance rate for system sizing shall be based upon the most hydraulically limiting naturally occurring soil texture from the ground surface to twelve (12) inches below the bottom of the proposed wastewater infiltration trenches.

(2) Installation Requirements

(a) Trench widths shall not exceed ten (10) feet.

(b) Wide trenches should be installed by excavating from the sides. Heavy equipment, such as backhoes, may not be placed in the trenches in order to avoid soil compaction.

(c) The required fill cap must extend at least five (5) feet beyond the limits of the wastewater infiltration trenches and must taper to the original soil surface at a slope not to exceed ten (10) percent. On sloping sites, where serial distribution has been incorporated into the system design, on the lower side and ends of the wastewater infiltration trenches, the fill cap must extend to at least ten (10) feet beyond the limits of the wastewater infiltration trenches and must taper to the original soil surface at a slope not to exceed five (5) percent. The required property line setback shall be measured from the point at which the fill cap taper intersects with the naturally occurring soil surface. The fill cap must be installed prior to beginning trench installation when required on the construction permit.

(3) Final Landscaping and Drainage

(a) Installation of drainage swales, ditches, diversion drains, or rain gutters may be required to divert or intercept water away from the onsite wastewater system location. The septic tank and subsurface wastewater infiltration area shall be backfilled and shaped to promote surface water runoff.

(b) A barrier to preclude parking and vehicular traffic over the area of the system may be required.

(c) Following final landscaping, seeding, or sodding may be required to prevent erosion.

UNIVERSITY OF NORTH CAROLINA DEPARTMENT OF HEALTH AND HUMAN SERVICES
 DIVISION OF PUBLIC HEALTH
 BUREAU OF ENVIRONMENTAL HEALTH SERVICES

ALTERNATIVE STANDARDS
 ALTERNATIVE TRENCH WIDTH & DEPTH SYSTEMS

PROGRAM 362 / CODE 290 / CODE 291 IF PUMPED

TYPICAL DESIGN ILLUSTRATION

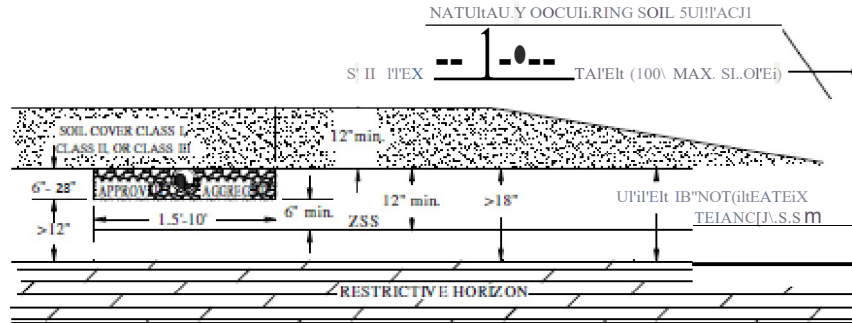

OTTO SCALE

FACTORS FOR MAINTAINING EQUIVALENT INFILTRATIVE SURFACE AREA

TRENCH DEPTH (ft.)	AGGREGATE DEPTH (in.)					
	6" *	9" **	14"	20"	14"	3"
1.5'	2.39	1.94	USE LOCAL STANDARD	1.10	0.97	0.37
2.0'	1.99	1.66	USE LOCAL STANDARD	1.00	0.39	0.50
2.5'	1.71	1.46	USE LOCAL STANDARD	0.91	0.3	0.75
3.0'	1.50	1.30	USE LOCAL STANDARD	0.84	0.76	0.70 <small>0.70</small>
4.0'	1.20	1.06	0.84	0.73	0.67	0.6
5.0'	1.00	0.839	0.73	0.64	0.59	0.55
6.0'	0.85	0.78	0.64	0.57	0.53	0.50
7.0'	0.74	0.68	0.57	0.52	0.49	0.46
8.0'	0.66	0.61	0.52	0.47	0.45	0.4
9.0'	0.59	0.55	0.47	0.43	0.41	0.39
10.0'	0.54	0.51	0.43	0.40	0.33	0.36

P = $\frac{5.33 \text{ sq.ft. ffl}}{2 (\text{SwDf} + \text{TW})}$

* Factors F1 reflect 1% increase
 ** Factors F2 reflect 9% increase
 See notes in context.

When $J.33 \text{ sq.ft.} = \text{total infiltrative surface area per linear foot of trench}$ (36 in. wide, 14 in. deep),
 SwD = Side Wall Depth (in)
 TW = Trench Width (ft.)

Rev. 03/09/18

Appendix L – System Standard 370/371 – Shallow Placement with Fill Cap for Sites with Shallow Class IV Soil

(1) Site/Permitting Requirements

(a) There must not be a zone of saturation (ZOS) within twelve (12) inches of the naturally occurring soil surface.

(b) The depth to any restrictive horizon must be greater than twelve (12) inches below the bottom of the proposed wastewater infiltration trenches.

(c) No part of this system can be installed within one hundred twenty-five (125) feet of the ordinary high water elevation within the banks of environmentally sensitive waters.

(d) This system may be considered for installation on contiguous lots in new subdivisions approved after the effective date of this standard provided a setback of at least seventy-five (75) feet is maintained between the system and all adjacent property lines. The seventy-five (75) foot setback shall be measured from the point at which the fill cap taper intersects with the naturally occurring soil surface.

(e) This system cannot be considered for facilities with peak sewage flow rates in excess of four hundred eighty (480) gpd. In addition, this system shall not be considered for facilities requiring grease traps.

(f) There shall be a replacement area equivalent to at least fifty (50) percent in size of the original system area held in reserve for system repair. This area shall have a suitable configuration and shall meet the minimum soil and site conditions of this regulation.

(g) The long-term acceptance rate for system sizing shall be based upon the most hydraulically limiting naturally occurring soil texture from the ground surface to twelve (12) inches below the bottom of the proposed wastewater infiltration trenches.

(2) Installation Requirements

(a) Effluent discharged to this system must receive a higher degree of treatment than that provided by a conventional septic tank (e.g. two (2) compartment septic tank or two (2) septic tanks in series).

(b) Where gravity flow from the septic tank to the subsurface wastewater infiltration area is utilized, the invert elevation of the septic tank outlet shall be installed at an elevation at least equal to or higher than the top of the aggregate in the highest wastewater infiltration trench(es).

(c) The required fill cap must extend at least five (5) feet beyond the limits of the wastewater infiltration trenches, and it must taper to the original soil surface at a slope not to exceed ten (10) percent. The required seventy-five (75) foot property line setback shall be measured from the point at which the fill cap taper intersects with the naturally occurring soil surface.

(d) The required fill material must be soil texture Class I, Class II, or Class III and be void of extraneous debris such as organic matter, building materials, etc.

(e) The depth of the fill cap shall provide a minimum of twelve (12) inches backfill above the top of the wastewater infiltration trench aggregate.

(f) The wastewater infiltration trench width shall be thirty-six (36) inches.

(g) All tree and brush removal shall be done in a manner that minimizes the disturbance or loss of naturally occurring soil.

(3) Final Landscaping and Drainage

(a) The septic tank and fill cap area shall be backfilled and shaped to promote the runoff of surface water.

(b) Where natural surface drainage does not exist, a swale shall be constructed adjacent to the filled area to divert surface water away from the onsite wastewater system to a positive outfall. The installation of ditches, curtain drains, and rain gutters may be required to intercept and divert water away from the onsite wastewater system location.

(c) A barrier to preclude parking and vehicular traffic over the system area may be required.

(d) Following final landscaping, seeding or sodding may be required to prevent erosion.

(e) Final approval shall be withheld until all landscaping and drainage improvements have been satisfactorily completed.

STATE OF NORTH CAROLINA DEPARTMENT OF HEALTH AND HUMAN SERVICES
 BUREAU OF ENVIRONMENTAL HEALTH SERVICES

ALTERNATIVE STANDARD
 SHALLOW PLACEMENT SYSTEM WITH MILL CAP FOR SITES WITH SHALLOW CLASS IV SOILS
 PROGRAM 16- / COD 370 / (0) DE 1711 E.P. MPED

TYPICAL DESIGN ILLUSTRATION

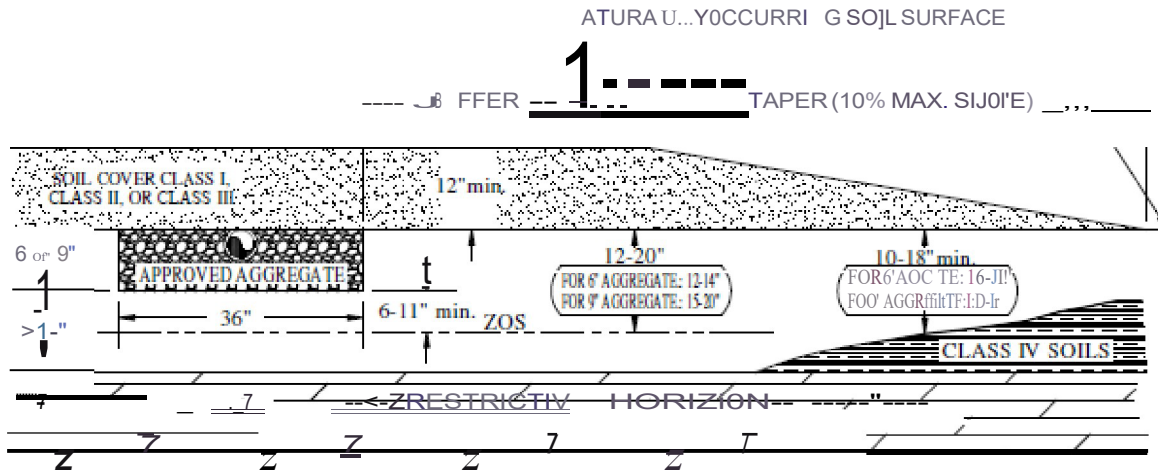

NOT TO SCALE

Depth to ZSS (in)	Depth to Class IV Soil (in)	Amount of Imported Fill Cn.p / Aggregate Depth (in)	tension factor
12	18	1216	1.3
13	17	1216	1.3
14	16	1216	1.3
---	---	---	---
15	15	1219	1.3
16	14	1219	1.3
17	13	1219	1.3
18	12	1219	1.3
19	11	1219	1.3
20	10	1219	1.3

Rev. 03/09/18

Appendix M – System Standard 380/381 – Double Aggregate Depth Wastewater Infiltration Trenches

(1) Site/Permitting Requirements

(a) Use of the double aggregate depth option must be restricted to soils that meet all textural limitations and required offsets to the zone of saturation (ZOS) and restrictive horizons.

(b) Systems incorporating the double aggregate depth option shall be loaded on the basis of the most hydraulically limiting naturally occurring soil texture from the ground surface to twelve (12) inches below the bottom of the proposed wastewater infiltration trenches.

(c) In order to maintain the same total absorptive area as that provided by conventional aggregate depth systems, the equivalent linear footage requirement for thirty-six (36) inch wide double aggregate depth trenches shall be determined by multiplying the conventional trench requirement by a factor of 0.7.

(d) There shall be a replacement area equivalent to at least fifty (50) percent in size of the original system area held in reserve for system repair. This area shall have a suitable configuration and shall meet the minimum soil and site conditions of this regulation.

(2) Installation Requirements

(a) The wastewater infiltration trench aggregate shall be twenty-eight (28) inches in depth and shall be placed so as to provide twenty (20) inches of aggregate below the pipe, five (5) inches beside the pipe, and three (3) inches above the pipe. The aggregate shall be covered with at least nine (9) inches of backfill.

(b) The wastewater infiltration trench width shall be thirty-six (36) inches.

(c) Where gravity flow from the septic tank to the subsurface wastewater infiltration area is utilized, the invert elevation of the septic tank outlet shall be installed at an elevation at least equal to or higher than the top of the aggregate in the highest wastewater infiltration trench(es).

(3) Final Landscaping and Drainage

(a) Installation of drainage swales, ditches, curtain drains, and rain gutters may be required to divert or intercept water away from the onsite wastewater system location. The septic tank and subsurface wastewater infiltration area shall be backfilled and shaped to promote surface water runoff.

(b) Following final landscaping, seeding or sodding may be required to prevent erosion.

(c) Final approval shall be withheld until all landscaping and drainage improvements have been satisfactorily completed.

COUNTY OF LOS ANGELES DEPARTMENT OF HEALTH AND HUMAN SERVICES
 BUREAU OF ENVIRONMENTAL HEALTH SERVICES

ALTERNATIVE STANDARD
 DOUBLE AGGREGATE DEPTH SOIL ABSORPTION TRENCHES

PROGRAM 360/00D 380/COD 381 IPPUMPED

TYPICAL DESIGN DETAIL

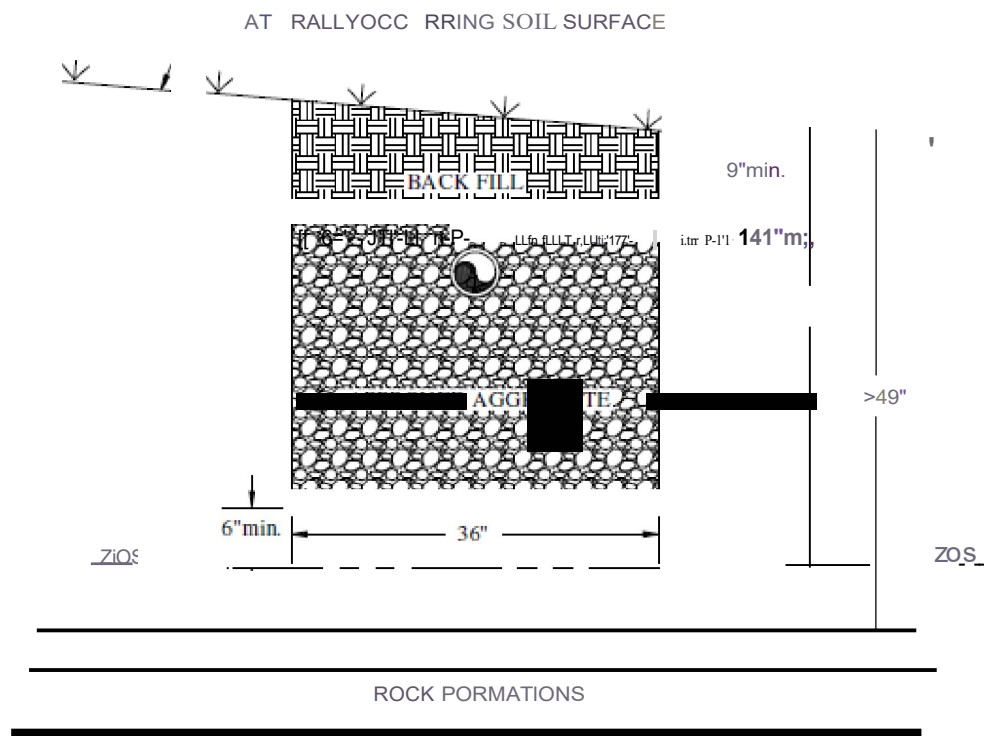

NOT TO SCALE

Rev. 00/09/18

Appendix N – System Standard 420/421 – Mounded Infiltration System

(1) Site/Permitting Requirements

- (a) The texture in the upper twelve (12) inches of naturally occurring soil must be Class I or Class II.
- (b) The soil texture in the permeable substratum must be no more limiting than Class II.
- (c) There must not be a zone of saturation (ZOS) within six (6) inches of the naturally occurring soil surface.
- (d) The depth to any restrictive horizon must be greater than twelve (12) inches below the bottom of the proposed wastewater infiltration trenches.
- (e) There shall be a replacement area equivalent to at least fifty (50) percent in size of the original system area held in reserve for system repair. This area shall have a suitable configuration and shall meet the minimum soil and site conditions of this regulation.
- (f) No part of this system can be installed within one hundred twenty-five (125) feet of the critical area line or tidal waters as determined by the Department; or within one hundred twenty-five (125) feet of the ordinary high water elevation within the banks of non-tidal, environmentally sensitive waters.
- (g) This system cannot be considered for facilities with peak flow rates in excess of four hundred eighty (480) gpd. In addition, this system shall not be considered for facilities requiring grease traps.
- (h) This system must not be utilized on sites that require serial distribution. Level installations on sloping sites can be considered if it can be demonstrated that the entire installation (i.e., side wall to side wall and end to end) will meet the required textural limitations and the required offsets to the zone of saturation and restrictive horizons.
- (i) The total linear footage of six (6) inch deep, thirty-six (36) inch wide wastewater infiltration trenches shall be increased by 100 percent over that which would be required for conventional trenches, as determined by the long-term acceptance rate of the permeable substratum.
- (j) This system may be considered for installation on contiguous lots in new subdivisions approved after the effective date of this standard provided a setback of at least seventy-five (75) feet is maintained between the system and all adjacent property lines. The seventy-five (75) foot setback shall be measured from the point at which the fill cap taper intersects with the naturally occurring soil surface.

(2) Installation Requirements

(a) Site Preparation

- (i) The naturally occurring soil surface underlying the area of the wastewater infiltration trenches shall be thoroughly tilled and mixed with the imported medium sand to a depth of six (6) inches.
- (ii) All tree and brush removal shall be done in a manner that minimizes the disturbance or loss of naturally occurring soil.

(b) Fill and System

- (i) The fill cap and buffer shall be Class I, Class II, or Class III.
- (ii) The depth of the fill cap shall provide a minimum of twelve (12) inches backfill above the top of the wastewater infiltration trench aggregate.
- (iii) Where gravity flow from the septic tank to the subsurface wastewater infiltration area is utilized, the invert elevation of the septic tank outlet shall be installed at an elevation at least equal to or higher than the top of the aggregate in the highest wastewater infiltration trench(es).
- (iv) The fill buffer shall be at least fifteen (15) feet in width.
- (v) The fill taper shall be at least twenty (20) feet in width.
- (vi) The required property line setback shall be measured from the point at which the fill cap taper intersects with the naturally occurring soil surface.
- (vii) The total fill depth, excluding the taper zone, shall be at least eighteen (18) inches above the naturally occurring soil surface.
- (viii) The wastewater infiltration trenches shall be installed in a Class I fill pad at least six (6) inches in depth, which extends five (5) feet beyond the trenches in all directions.
- (ix) The wastewater infiltration trenches require a total aggregate depth of six (6) inches.
- (x) The wastewater infiltration trench width shall be thirty-six (36) inches.
- (xi) Infiltration trenches shall penetrate the permeable substratum and shall be at least two (2) feet in width containing USDA medium sand, washed concrete sand, or other material approved by the Department.
- (xii) Effluent discharged to this system must receive a higher degree of treatment than that provided by a conventional septic tank (e.g., two (2) compartment septic tank or two (2) septic tanks in series).

(3) Final Landscaping and Drainage

- (a) The septic tank and fill cap area shall be backfilled and shaped to promote the runoff of surface water.
- (b) Where natural surface drainage does not exist, a swale shall be constructed adjacent to the filled area to divert surface water away from the onsite wastewater system to a positive outfall. The installation of ditches, curtain drains, and rain gutters may be required to intercept and divert water away from the onsite wastewater system location.
- (c) A barrier to preclude parking and vehicular traffic over the system area may be required.
- (d) Following final landscaping, seeding or sodding may be required to prevent erosion.
- (e) Final approval shall be withheld until all landscaping and drainage improvements have been satisfactorily completed.

**North Carolina DEPARTMENT OF HEALTH AND ENVIRONMENTAL CONTROL
BUREAU OF ENVIRONMENTAL HEALTH SERVICES**

ALTERNATIVE STANDARD
MOUNDED INFILTRATION SYSTEM FOR PERMEABLE SANDS UNDERLYING RESTRICTIVE HORIZONS

PROGRAM 362 / CODE 421 / CODE 421 IF PUMPED

TYPICAL DESIGN ILLUSTRATION

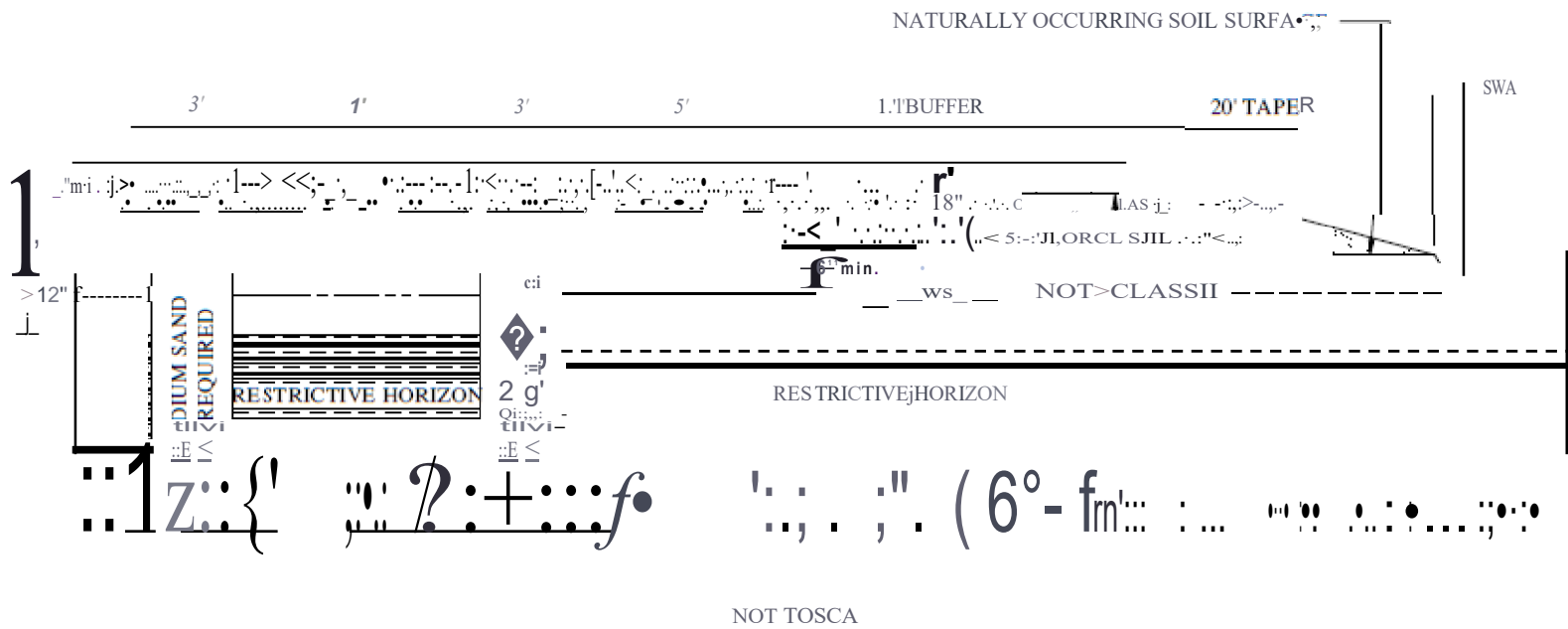

Rev. 03/09/18

Appendix O – System Standard 431 – Mounded Fill System

(1) Site/Permitting Requirements

- (a) The texture in the upper eighteen (18) inches of naturally occurring soil must be Class I or Class II.
- (b) The absorption bed within the mound shall be sized on the long-term acceptance rate of the most limiting texture in the upper eighteen (18) inches of naturally occurring soil.
- (c) The linear footage of the absorption bed shall be determined in accordance with Standard 270.
- (d) The absorption bed width shall be a minimum of five (5) feet and a maximum of 10 feet.
- (e) Mounded fill systems must not be placed on sites with a slope in excess of three (3) percent.
- (f) No part of this system can be installed within one hundred twenty-five (125) feet of the critical area line or tidal waters as determined by the Department; or within one hundred twenty-five (125) feet of the ordinary high water elevation within the banks of non-tidal, environmentally sensitive waters. Because of the long buffer, side slope, fill pad, and taper associated with this system, the one hundred twenty-five (125) foot setback shall be measured from the outer edge of the aggregate bed within the mound.
- (g) There shall be a replacement area equivalent to at least fifty (50) percent in size of the original system area held in reserve for system repair. This area shall have a suitable configuration and shall meet the minimum soil and site conditions of this regulation.
- (h) This system cannot be considered for facilities with peak flow rates in excess of four hundred eighty (480) gpd. In addition, this system shall not be considered for facilities requiring grease traps.
- (i) Effluent discharged to this system must receive a higher degree of treatment than that provided by a conventional septic tank (e.g., two (2) compartment septic tank or two (2) septic tanks in series).
- (j) This system may be considered for installation on contiguous lots in new subdivisions approved after the effective date of this standard provided a setback of at least seventy-five (75) feet is maintained between the system and all adjacent property lines. Because of the long buffer, side slope, fill pad, and taper associated with this system, the seventy-five (75) foot setback shall be measured from the outer edge of the aggregate bed within the mound.

(2) Installation Requirements

(a) Site Preparation

- (i) If present within eighteen (18) inches of the naturally occurring soil surface, organic material and restrictive horizons must be removed from beneath the mound and replaced with USDA medium sand, washed concrete sand, or an equivalent material approved by the Department. The replacement area must extend five (5) feet in all directions beyond the edges of the aggregate filled absorption bed.
- (ii) The naturally occurring soil surface underlying the mound shall be thoroughly tilled and mixed with the imported mound fill material to a depth of six (6) inches.

(b) Mound/Absorption Bed Requirements

(i) Low Pressure Pipe Distribution (LPP) must be utilized to preclude localized hydraulic overloading of the imported fill material and to minimize the impact on the shallow zone of saturation.

(ii) Low Pressure Pipe Distribution (LPP) must be designed and installed in accordance with Department standards or equivalent designs. The size and layout of each distribution system will vary based on the size of the filter and the needed dosing.

(iii) Pump design shall be in accordance with Department standards.

(iv) There must be at least twenty-four (24) inches of medium sand placed between the naturally occurring soil surface and the bottom of the absorption bed. The bottom surface of the absorption bed must be placed at least twenty-four (24) inches above the zone of saturation.

(v) If the slope of the site in the proposed mound area is one (1) percent or less, then the mound shall be placed on a twelve (12) inch fill pad which must extend twenty (20) feet beyond the mound in all directions. If the slope of the site in the proposed mound area is greater than one (1) percent but less than or equal to three (3) percent, then the mound shall be placed on a twelve (12) inch deep fill pad which must extend twenty (20) feet beyond the mound area on the sides of the mound; forty (40) feet beyond the mound area on the down-slope side of the mound; with no fill pad required on the upslope side of the mound.

(vi) The mound and fill pad material shall be USDA medium sand, washed concrete sand, or other equivalent material approved by the Department.

(vii) The depth of the fill cap material above the absorption bed shall be nine (9) to fifteen (15) inches of soil texture Class II or Class III. Sod may be substituted for four (4) inches of this portion of the fill cap material.

(viii) The depth of the fill cap material above the mound side-slope, the twelve (12) inch deep fill pad, and the taper shall be at least four (4) inches of soil texture Class II or Class III. Sod may be substituted for this portion of the fill cap material.

(ix) A 1:2 maximum slope is required if the mound side-slope and taper are sodded.

(x) A 1:4 maximum slope is required if the mound side-slope and taper are mulched and seeded.

(3) Final Landscaping and Drainage

(a) The septic tank and mound area shall be backfilled and shaped to promote the runoff of surface water.

(b) Where natural surface drainage does not exist, a swale shall be constructed adjacent to the filled area to divert surface water away from the onsite wastewater system to a positive outfall. The installation of ditches, curtain drains, and rain gutters may be required to intercept and divert water away from the onsite wastewater system location.

(c) A barrier to preclude parking and vehicular traffic over the system area may be required.

(d) Following final landscaping, seeding, or sodding may be required to prevent erosion.

(e) Final approval shall be withheld until all landscaping and drainage improvements have been satisfactorily completed.

ITH CAROLINA DEPARTMENT OF HEALTH AND ENVIRONMENTAL CONTROL
 BUREAU OF ENVIRONMENTAL HEALTH SERVICES

ALTERNATIVE STANDARD
 MOUND FILL SYSTEMS

PROC 362 / CODE 431

TYPICAL DESIGN ILLUSTRATION A

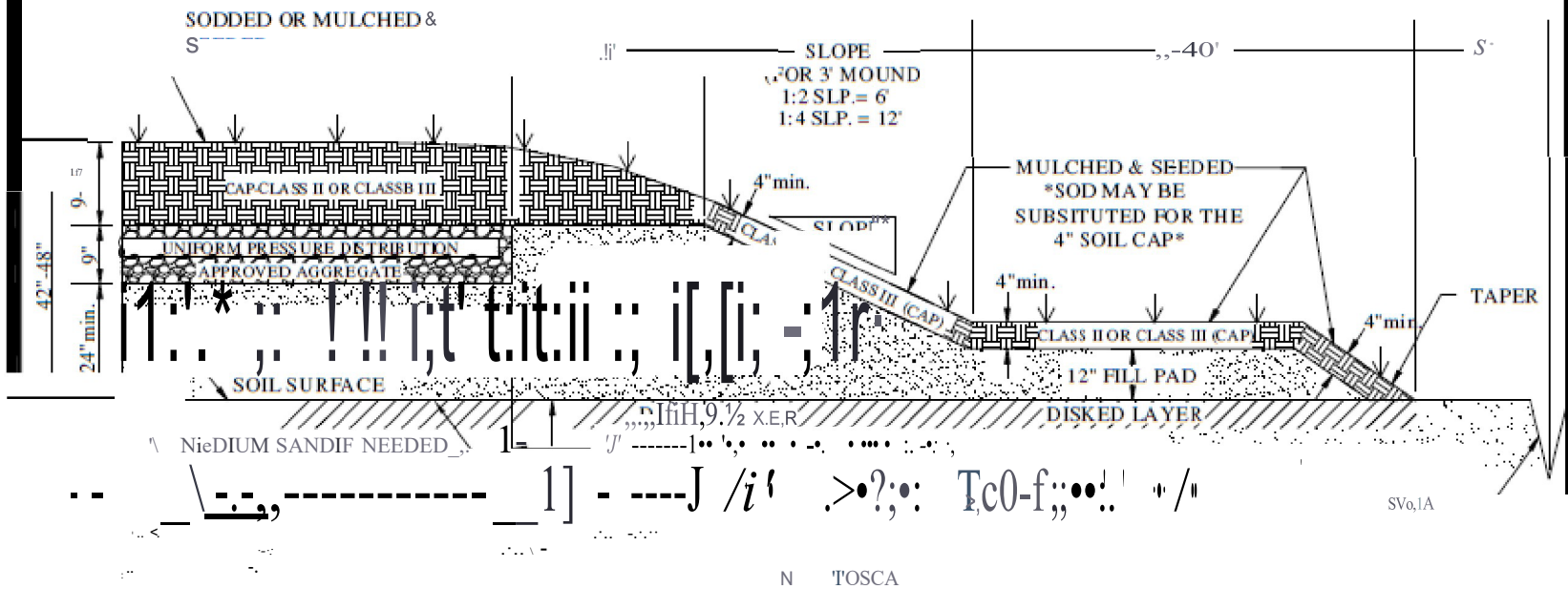

MAX. SIDE SLOPE SHALL BE 1:2 IF SODDED
 OR 1:4 IF MULCHED & SEEDDED

Rev. 03/09/18

SOUTH CAROLINA DEPARTMENT OF HEALTH AND ENVIRONMENTAL CONTROL
BUREAU OF ENVIRONMENTAL HEALTH SERVICES

ALTERNATIVE STANDARD
MOUNDED FILL SYSTEMS
PROGRAM 362 / CODE 431
TYPICAL DESIGN ILLUSTRATION B

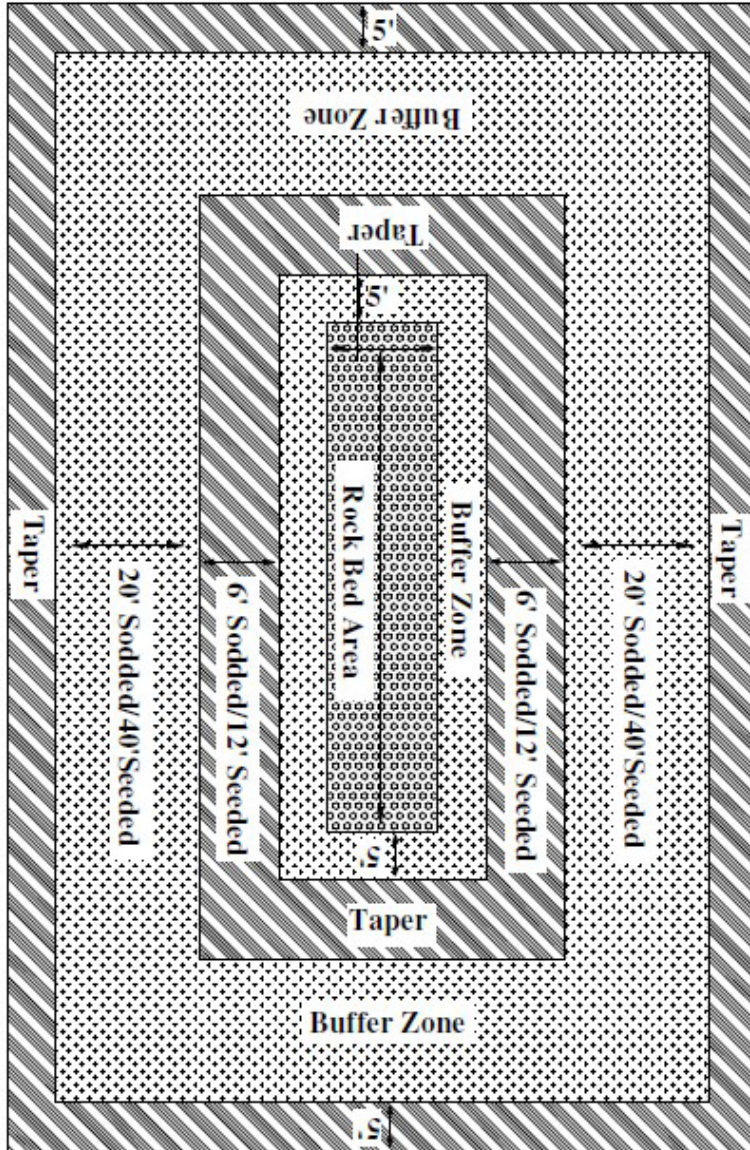

NOT TO SCALE

Rev. 03/09/18

SOUTH CAROLINA DEPARTMENT OF HEALTH AND ENVIRONMENTAL CONTROL
BUREAU OF ENVIRONMENTAL HEALTH SERVICES

ALTERNATIVE STANDARD
MOUND FILL SYSTEMS
PROGRAM 362 / CODE 431
TYPICAL DESIGN ILLUSTRATION C

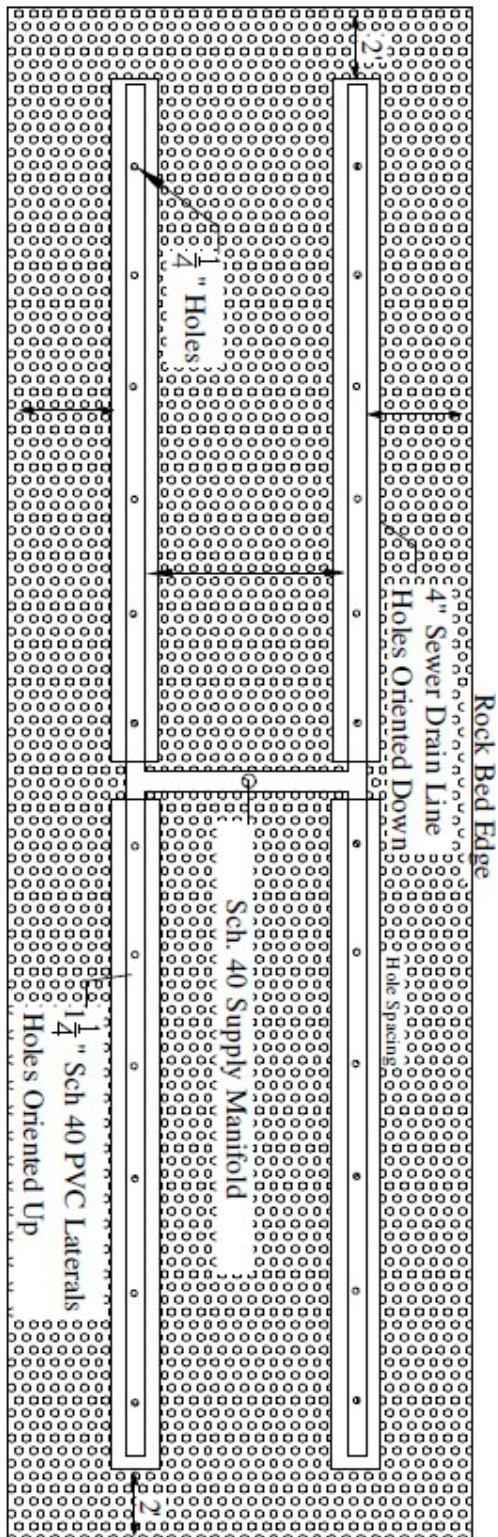

*Note: Cleanouts are required at the end of each lateral to extend to finishing grade with screw-on cleanout caps.

NOT TO SCALE

Rev. 03/09/18

Appendix P – System Standard 601 – Elevated Infiltration System

(1) Site/Permitting Requirements

- (a) The texture in the upper eighteen (18) inches of naturally occurring soil must be Class I or Class II.
- (b) The filter shall not be placed on slopes greater than three (3) percent.
- (c) This system cannot be considered for facilities with peak flow rates in excess of four hundred eighty (480) gpd. This system shall not be considered for facilities requiring grease traps.
- (d) There shall be a buffer of at least fifty (50) feet surrounding and separating the system from all adjacent property lines. This buffer shall be measured from the retaining wall.
- (e) There shall be a replacement area equivalent to at least fifty (50) percent in size of the original system area held in reserve for system repair. This area shall have a suitable configuration and shall meet the minimum soil and site conditions of this regulation.
- (f) No part of this system can be installed within one hundred twenty-five (125) feet of the critical area line or tidal waters as determined by the Department or within one hundred twenty-five (125) feet of the ordinary high water elevation within the banks of non-tidal, environmentally sensitive waters.
- (g) The total bottom area of the filter must be increased by fifty (50) percent above that required for conventional trenches.
- (h) This system may be considered for installation on contiguous lots in new subdivisions approved after the effective date of this standard provided a setback of at least seventy-five (75) feet is maintained between the system and all adjacent property lines. The seventy-five (75) foot setback shall be measured from the point at which the retaining wall intersects the naturally occurring soil surface.

(2) Installation Requirements

(a) Site Preparation

- (i) If present within eighteen (18) inches of the naturally occurring soil surface, organic material and restrictive horizons must be removed from beneath the filter and replaced with USDA medium sand, washed concrete sand, or an equivalent material approved by the Department.
- (ii) The naturally occurring soil surface underlying the filter shall be thoroughly tilled and mixed with the imported filter material to a depth of six (6) inches.

(b) System Requirements

- (i) The filter must be constructed to a height of at least thirty-six (36) inches above the original grade with the sewage effluent passing through at least twenty-four (24) inches of filter material.
- (ii) The filter material shall be USDA medium sand, washed concrete sand, or other material approved by the Department.

(iii) The filter retaining wall shall extend at least four (4) inches above the surface of the filter material and shall penetrate the naturally occurring soil surface at least four (4) inches.

(iv) The filter retaining wall shall be constructed in accordance with the accompanying design illustrations.

(v) Effluent discharged to this system must receive a higher degree of treatment than that provided by a conventional septic tank (e.g., two (2) compartment septic tank or two (2) septic tanks in series).

(vi) The top of the filter shall be capped with Class II or Class III soil and shall slope from center to edges in order to promote surface runoff.

(c) Distribution Requirements

(i) Low Pressure Pipe Distribution (LPP) must be utilized to preclude localized hydraulic overloading of the imported fill material and to minimize the impact on the shallow zone of saturation.

(ii) Low Pressure Pipe Distribution (LPP) must be designed and installed in accordance with Department standards or equivalent designs. The size and layout of each distribution system will vary based on the size of the filter and the needed dosing.

(iii) Pump design shall be in accordance with Department standards.

(3) Final Landscaping and Drainage

(a) Fill material shall be placed around the outside of the filter to a depth of one (1) foot, and shall slope to original grade at a point five (5) feet from the retaining wall.

(b) The septic tank and filter area shall be backfilled and shaped to promote the runoff of surface water.

(c) Where natural surface drainage does not exist, a swale shall be constructed adjacent to the filter to divert surface water away from the onsite wastewater system to a positive outfall. The installation of ditches, curtain drains, and/or rain gutters may be required to intercept and divert water away from the onsite wastewater system location.

(d) Following final landscaping, seeding or sodding may be required to prevent erosion.

(e) Final approval shall be withheld until all landscaping and drainage improvements have been satisfactorily completed.

0 TH AROLI DEP RTMEI F HIE LTHA DIE VIRO ME 'AL O 'FROL
 B RE UOFIE VIR01 MEI 'f L HE LTH SERVICES

ALTERNATIV STANDARD
 EIJ VATEO INFILTRATION SYSTEM

PROGRAM 362 / CODE 601

TYP I. DE IG TRATION - **IGURE A**
 SQUAR CONCRETE& BLOCK FILT AILS

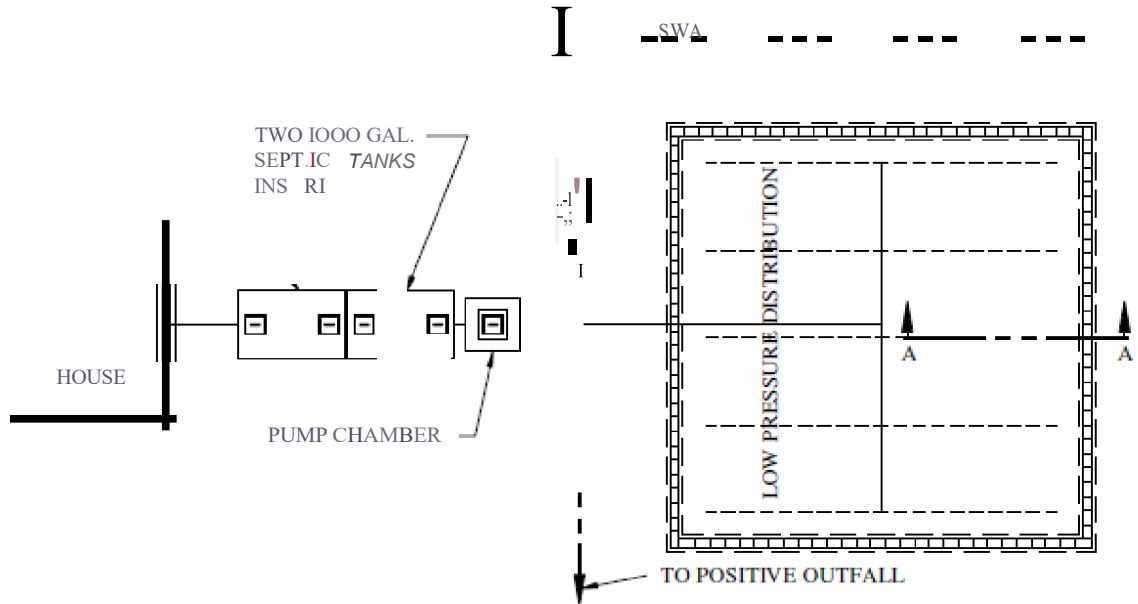

PLAN VIEW
 NOT 1/10 SCALE

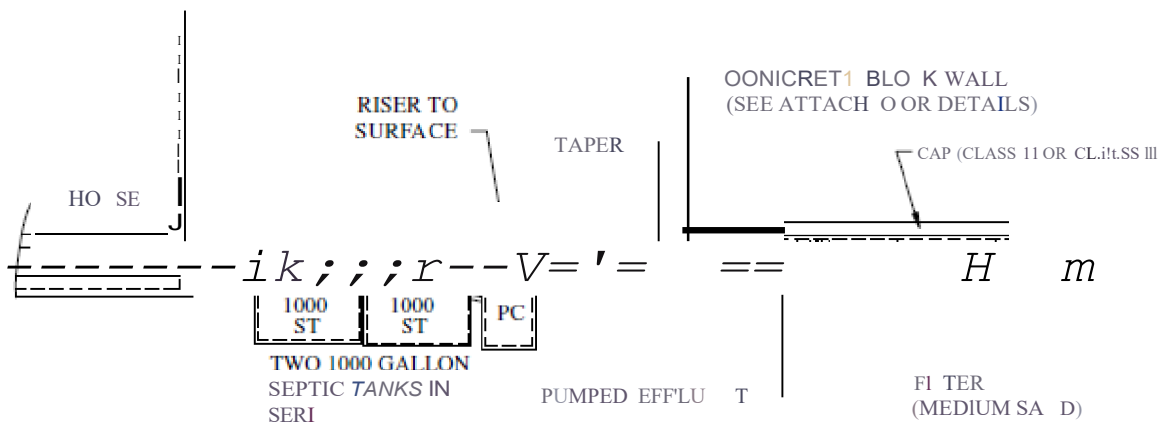

ELEVATION
 NOT TO SCALE

Rev. 03/09/18

OUTH CAROLI DEPART ENT OF HEALTH DE, IRO TE TAL, 0 FROL
 B REAU OF E IRON ENTAL HEALTH SERVICES

A TER TIVE STANDARD
 LEVATED INHLTIRATION S¥STEM

PROGRAM 362 / COD 60

TYPICAL DESI ILLUSTRATION 1G R A
CIRCULAR STEEL FI TE:R DE.TAILS

SWALE

AGRICULTURAL GRAIN STORAGE BIN
STEEL SHEETING GALVANIZED

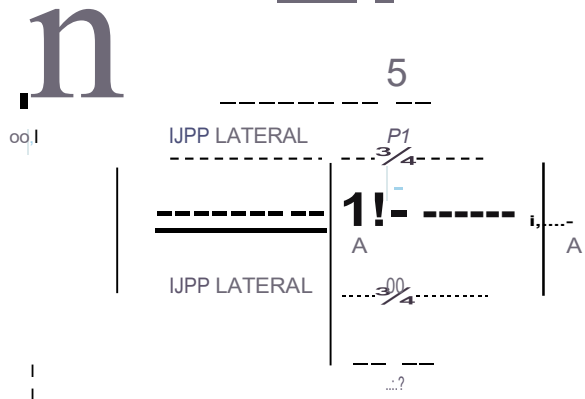
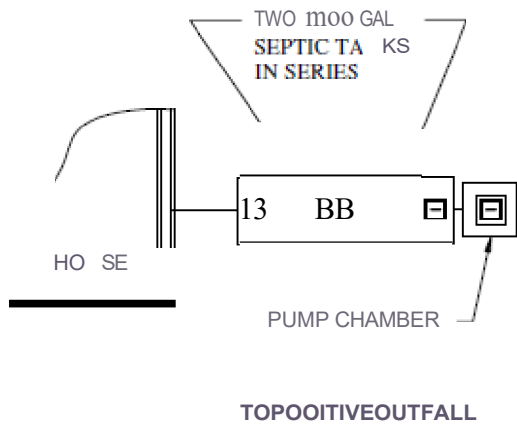

NOT : INSID WILL B COATED OR LINED
 TO PREVE T CORROSIO
 JOI TS MUST BE SEA D WITII
 WATER PROOF CAULKING

PLAN VIEW
 NOT TO SCALE

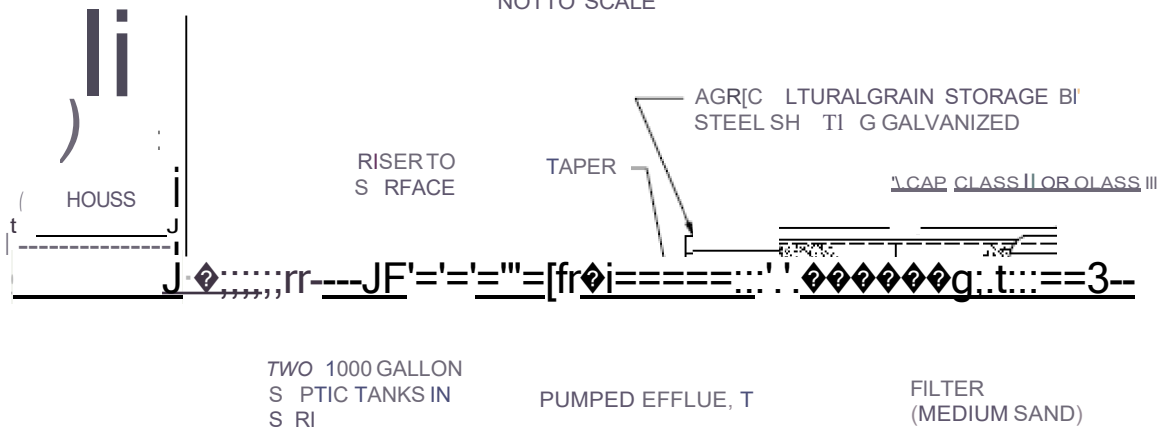

ELEVATION
 NOT TO SCALE

Rev. 03/09/18

0 TH ROLI A DEP RTME. T OF HE.ALTH A 'IDE '\,IRO ME. TAL ONTR0L
 B REA OF E IRO IE TAL H ALTH SERVICES

ALTE!RNAT]VE!STA □ARD
 E!LE!VATE!D] FILTRATIO SYSTEM

PROGRAM 362!DQD 601

TYPI, L IL!E IGN ILLU TR TJOI • FIG RE B
SO ARE CO CR TE: & BLOCK FILTERD TAILS

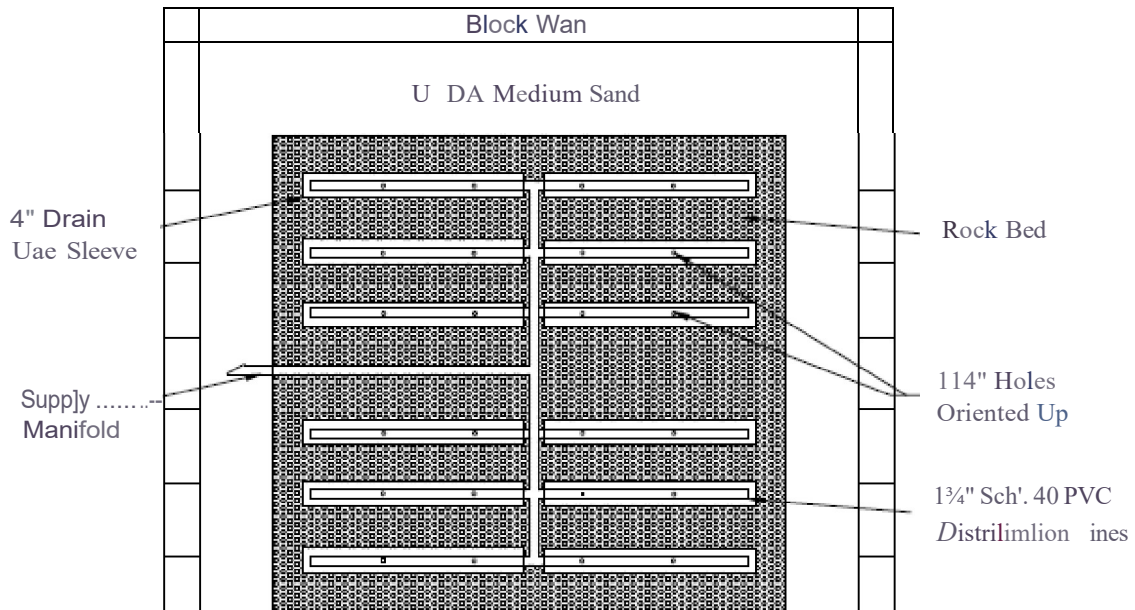

**Dimension.s calculated based 0,1 inside
 area of Block Wall**

. ACH LATBRAL TO B. INSIALL DI A ROCK BED

ALL LATERAL PR.SS R. LI ES ARE REQUJ RBD TO HAVE EIJBOWS AT TH. DS O. EACH
 U EAND. XTE D TOFINISHI G GRAD WITH S:CREW_JON CL ANOUTCAPS

ALL HOLES ARB TO B ,QUALLY SPAC, D FIROM , NDS OF EACH LINE.AND BETWEEN! EACH
 HOLJE

ELEVATION
 NOT TO SCALE

Rev. 03/09/18

0 TH ROLI AD PARTME T OF HEALTH A M E "IR:O IE TAL O ROL
 B REAU OF E 'VIRO MENI'AL HEALTH SERVICES

A TERNATIVE STA DARD
 E!LHVATE!DI FILT!RATIO SYSTEM

PROGRAM 362700D 601

'FYI'[, LIDE IGN ILLU TR 'fION • 111G RE R
 CIRC LAR STEEL FILTER DIITAILS

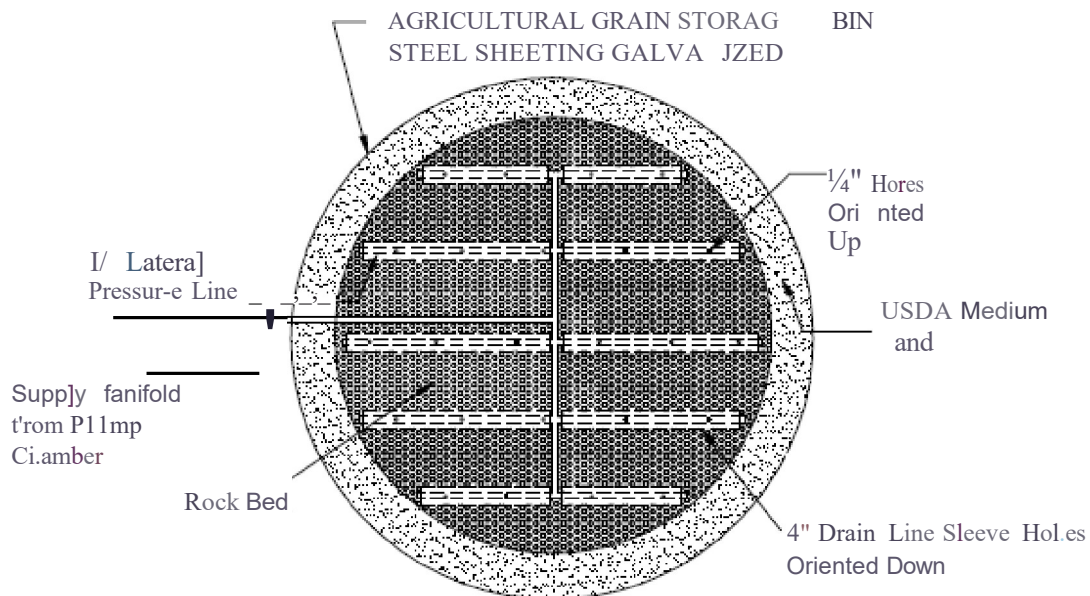

EACH LATERAL TO BE INSTALLED A ROCK BED

ALL LATERAL PRESSURE LINES ARE REQUIRED TO HAVE ELBOWS AT THE ENDS OF EACH LINE AND EXTENDED TO FINISH GRADE WITH SCREW-ON CLEAN OUT CAPS

ALL HOLES ARE TO BE EQUALLY SPACED FROM END OF EACH LINE AND BETWEEN EACH HOLE

ELEVATION
 NOT TO SCALE

Rev. 03/09/18

STATE OF NORTH CAROLINA DEPARTMENT OF HEALTH AND HUMAN SERVICES
 DIVISION OF PUBLIC HEALTH SERVICES

ALTERNATIVE STANDARD
 ELEVATED INFILTRATION SYSTEM

PROGRAM 3600 / 00DE 601

DESIGN DETAILS - FIGURE C

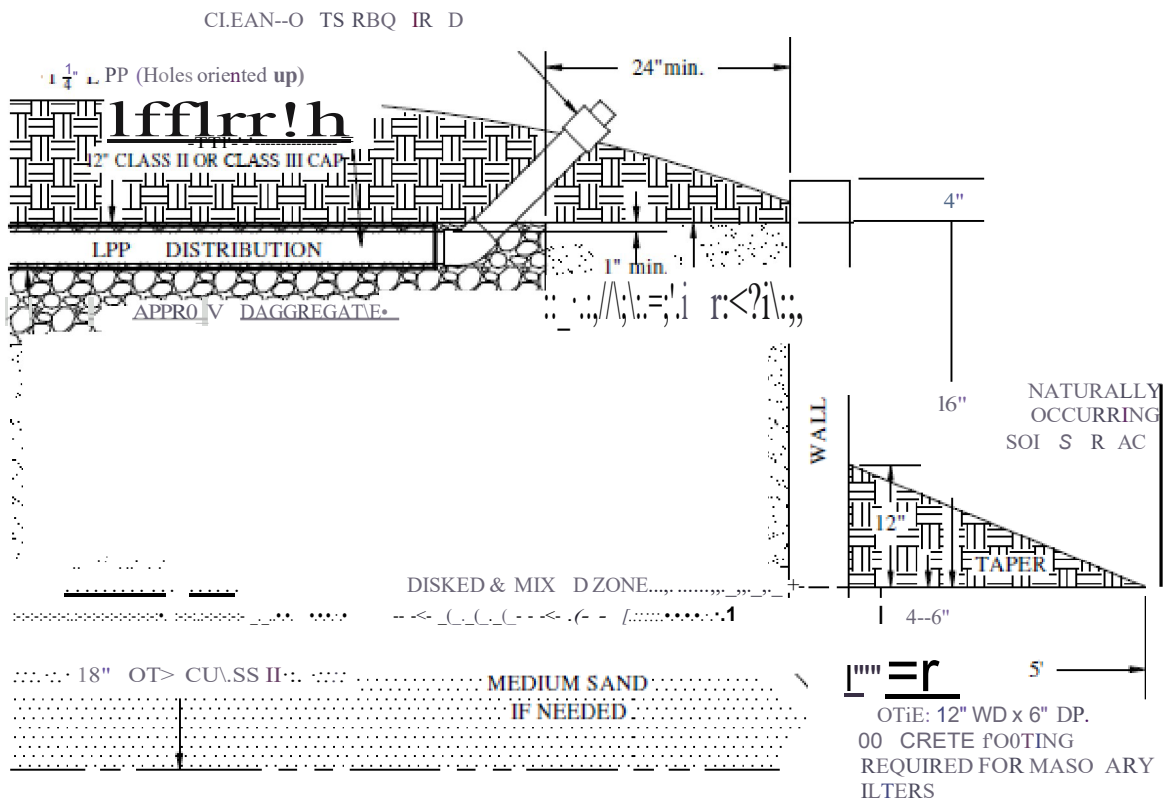

NOT TO SCALE

Rev. 03/09/18

Appendix Q – System Standard 610 – Specialized Onsite Wastewater System Designs (less than 1500 gpd)

(1) Site/Permitting Requirements

(a) This Standard shall not apply to the following:

- (i) Projects where two (2) or more pieces of deeded property will share a common system.**
- (ii) Residential or commercial projects where the individual or combined peak sewage flow is estimated to be in excess of fifteen hundred (1500) gpd.**
- (iii) Projects that discharge wastes containing high amounts of fats, grease and oil, including restaurants and other food service facilities, unless the system manufacturer certifies that the proposed system is designed to treat such high strength wastes.**
- (iv) Industrial process wastewater.**

(b) A site may be considered for a specialized onsite wastewater system design if written documentation provided by a Registered Professional Engineer licensed in South Carolina, including soil studies performed by a licensed person meeting the criteria of Section 102.1(2)(b) or (c), indicates that the proposed system will function satisfactorily and in accordance with all requirements of this regulation. Such substantiating documentation must include the following:

(i) A Soils Report from a licensed person meeting the criteria of Section 102.1(2)(b) or (c) including detailed soil profile descriptions and Soil Series classification(s) utilizing methods and terminology specified in the Field Book for Describing and Sampling Soils; depth to the zone of saturation utilizing methods and terminology outlined in Redoximorphic Features for Identifying Aquic Conditions, and other appropriate principles specified in Soil Taxonomy; the depth to restrictive horizons; and a description of topography and other pertinent land features.

(ii) For drain field and replacement areas with a less than fifteen (15) inch zone of saturation, no part of a specialized onsite wastewater system may be installed within one hundred twenty-five (125) feet of the critical area line or tidal waters as determined by the Department or within seventy-five (75) feet of the ordinary high water elevation within the banks of non-tidal, environmentally sensitive waters.

(iii) There shall be a replacement area equivalent to at least fifty (50) percent in size of the original system area held in reserve for system repair. This area shall have a suitable configuration and shall meet the minimum soil and site conditions of this regulation.

(iv) A plan that has been sealed, signed and dated by a Registered Professional Engineer licensed in South Carolina certifying that the proposed onsite wastewater system has been designed in accordance with the requirements of this regulation and will function satisfactorily. The plan should also show an area equivalent to at least fifty (50) percent in size of the original system held in reserve for system repair.

(v) The manufacturer's recommendations for operation and maintenance of the system, and the consulting Registered Professional Engineer's management plan to meet this. For systems that have mechanical components and/or require a higher degree of maintenance to ensure the proper treatment and disposal of Domestic Wastewater, an operation and maintenance (O&M) plan must be developed by the designing Registered Professional Engineer to be given to the party who is ultimately responsible for the

operation of the system. O&M plans must be recorded along with the property deed and must run with the land.

(c) Any permit to construct that is issued pursuant to this standard shall be based upon the consulting Registered Professional Engineer's design, certification, and other supporting documentation provided by the licensed person meeting the criteria of Section 102.1(2)(b) or (c).

(d) The consulting Registered Professional Engineer shall be responsible for supervising construction of the system and providing the Department with a certified as-built plan of the actual installation containing all details required by the Department. The certified as-built plan must be submitted to the Department within two (2) business days of completing the system installation. If the construction schedule for a specialized system installation is more than forty-eight (48) hours, the Department must be notified in advance of the beginning of construction. Any Final Approval that is released pursuant to this standard shall be based upon this engineering certification.

Appendix R – Curtain Drain Standard

(1) Minimum Construction Requirements

(a) Only pipe having received written approval from the Department may be utilized in curtain drains. This approval shall be based upon the pipe meeting all applicable ASTM standards.

(b) The aggregate used in curtain drains shall be a material approved by the Department.

(c) The curtain drain trench utilizing tire chips or gravel or a similar type of Department approved product shall be at least six (6) inches wide.

(d) The curtain drain shall be placed ten (10) feet upslope and twenty-five (25) feet down-slope of a subsurface wastewater infiltration area or repair area. Where the aggregate portion of the curtain is installed at the same or lower (down-slope) elevation relative to an adjacent subsurface wastewater infiltration area or repair area, the aggregate portion of the curtain must be a minimum of twenty-five (25) feet from the adjacent subsurface wastewater infiltration area or repair area.

(e) The trench bottom shall have a uniform slope to the discharge point. Trench excavation with a ditch witch is permissible provided the trench bottom has a uniform down-slope gradient.

(f) The solid discharge (non-aggregate) line shall be fifteen (15) feet from adjacent subsurface wastewater infiltration area or repair area.

(g) The down-slope side of the trench toward the subsurface wastewater infiltration area shall have a minimum six (6) mil poly or an equivalent strength treated impervious material draped from the trench surface to the trench bottom to prevent groundwater from bridging the curtain drain.

(h) Agricultural drainpipe (slitted) with a minimum diameter of four (4) inches shall be placed along the trench bottom in the aggregate portion. Perforated pipe is acceptable, provided the perforations are installed facing either sideways or upward.

(i) There shall be at least two (2) inches of aggregate beneath the drainpipe.

(j) The aggregate shall be brought to at least six (6) inches from the ground surface.

(k) The aggregate shall be covered with a strong, untreated pervious material to prevent infiltration of back fill material.

(l) Solid drainpipe with a minimum diameter of four (4) inches shall be placed along the trench bottom from the aggregate to the discharge point.

(m) The curtain drain must discharge to the ground surface past the last wastewater infiltration trench line.

(n) Rodent barriers on discharge pipe outlet(s) are required.

(o) If the curtain drain's trench bottom depth exceeds thirty (30) inches, it shall be inspected prior to the aggregate being installed to ensure proper trench depth and grade. It is acceptable to place the pipe and aggregate in the trench prior to the final inspection when a probe rod inspection port can be used to accurately measure trench bottom depth.

**SOUTH CAROLINA DEPARTMENT OF HEALTH AND ENVIRONMENTAL CONTROL
BUREAU OF ENVIRONMENTAL HEALTH SERVICES**

CURTAIN DRAIN STANDARD

TYPICAL DESIGN SKETCH

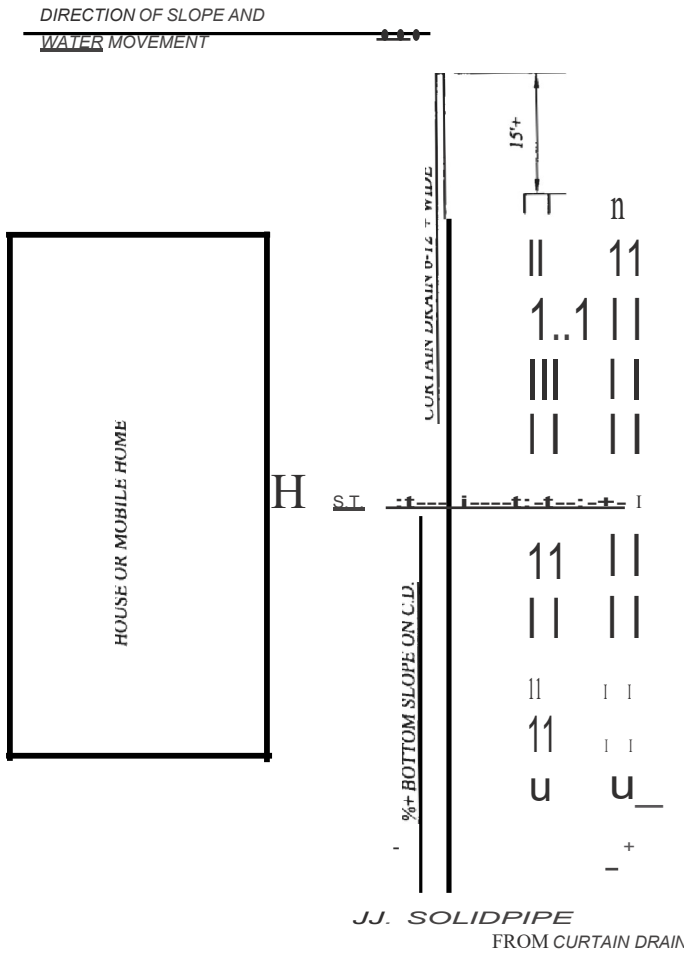

NOTE:
DEPTH OF CURTAIN DRAIN WILL VARY DEPENDING UPON SOIL CONDITIONS.

FOR CURTAIN DRAIN INSTALLATION IN SOILS WITH PERMEABLE UPPER HORIZONS AND UNDERLYING LESS PERMEABLE OR RESTRICTIVE HORIZONS SEE SECTION A-A ON DRAWING B.

FOR CURTAIN DRAIN INSTALLATION IN SOIL WITH RELATIVELY UNIFORM TEXTURED HORIZONS SEE SECTION A-A ON DRAWING C.

NOTE:
IF GRAVEL IS PLACED ON THE DISCHARGE SIDE OF THE CURTAIN DRAIN, WHEN USED ON COMPOUND SLOPES, THE OFFSET TO THE DRAINLINES SHALL BE INCREASED TO 25 FT OR GREATER.

{DISCHARGE WITH RODENT BARRIER

DIRECTION OF SLOPE AND WATER MOVEMENT

SECTIONAL VIEW A-A AS SHOWN ON DRAWINGS B & C

DRAWING A

SOUTH CAROLINA DEPARTMENT OF HEALTH AND ENVIRONMENTAL CONTROL
 BUREAU OF ENVIRONMENTAL HEALTH SERVICES

CURTAIN DRAIN STANDARDS

CURTAIN DRAIN INSTALLATION IN SOILS WITH RESTRICTIVE OR LESS PERMEABLE HORIZONS BELOW THE DRAINFIELD

TYPICAL DESIGN SKETCH

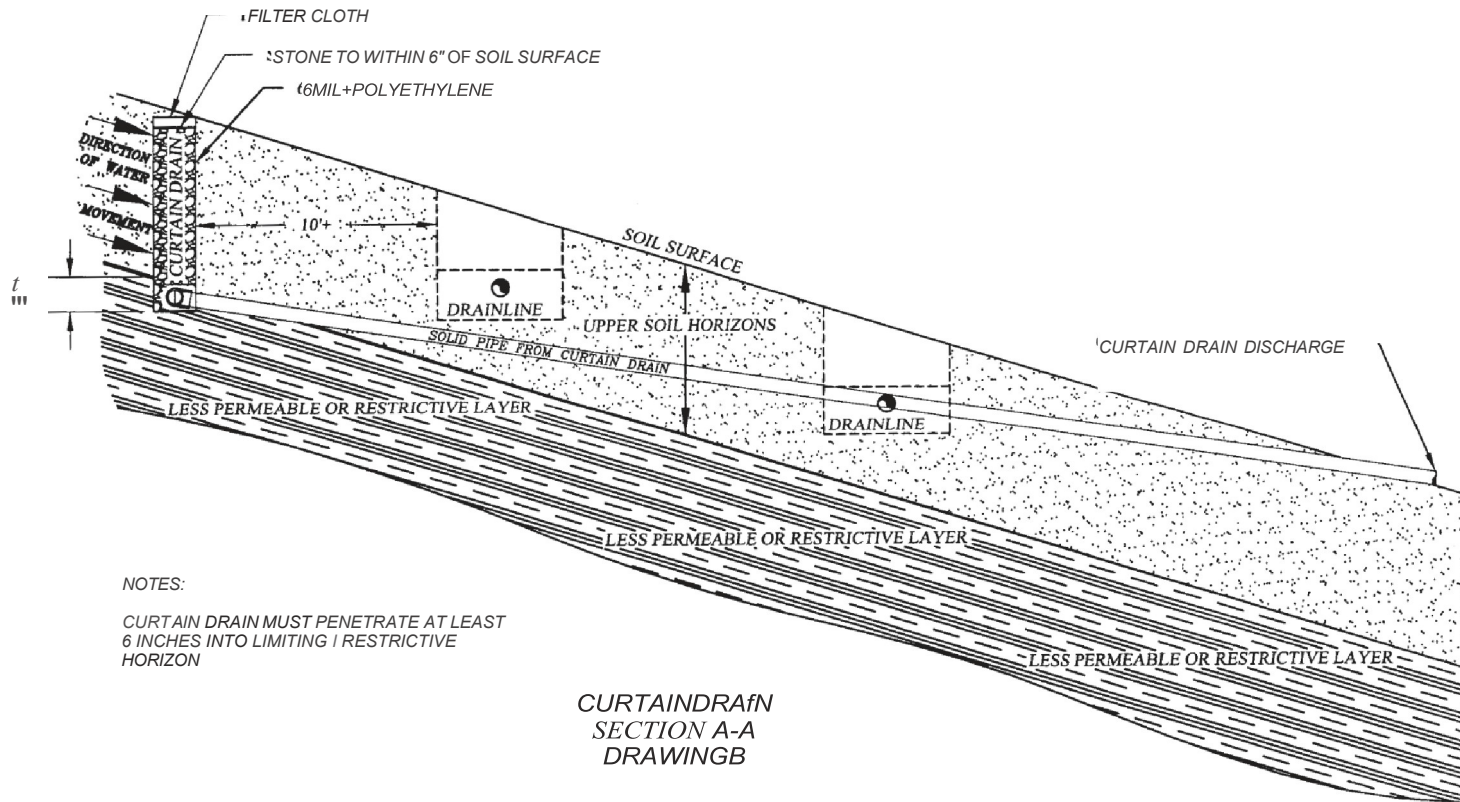

NOTES:

CURTAIN DRAIN MUST PENETRATE AT LEAST
 6 INCHES INTO LIMITING / RESTRICTIVE
 HORIZON

CURTAIN DRAIN
 SECTION A-A
 DRAWING B

**SOUTH CAROLINA DEPARTMENT OF HEALTH AND ENVIRONMENTAL CONTROL
BUREAU OF ENVIRONMENTAL HEALTH SERVICES**

CURTAIN DRAIN STANDARDS

CURTAIN DRAIN INSTALLATION IN SOILS WITH RELATIVELY UNIFORM HORIZONS

TYPICAL DESIGN SKETCH

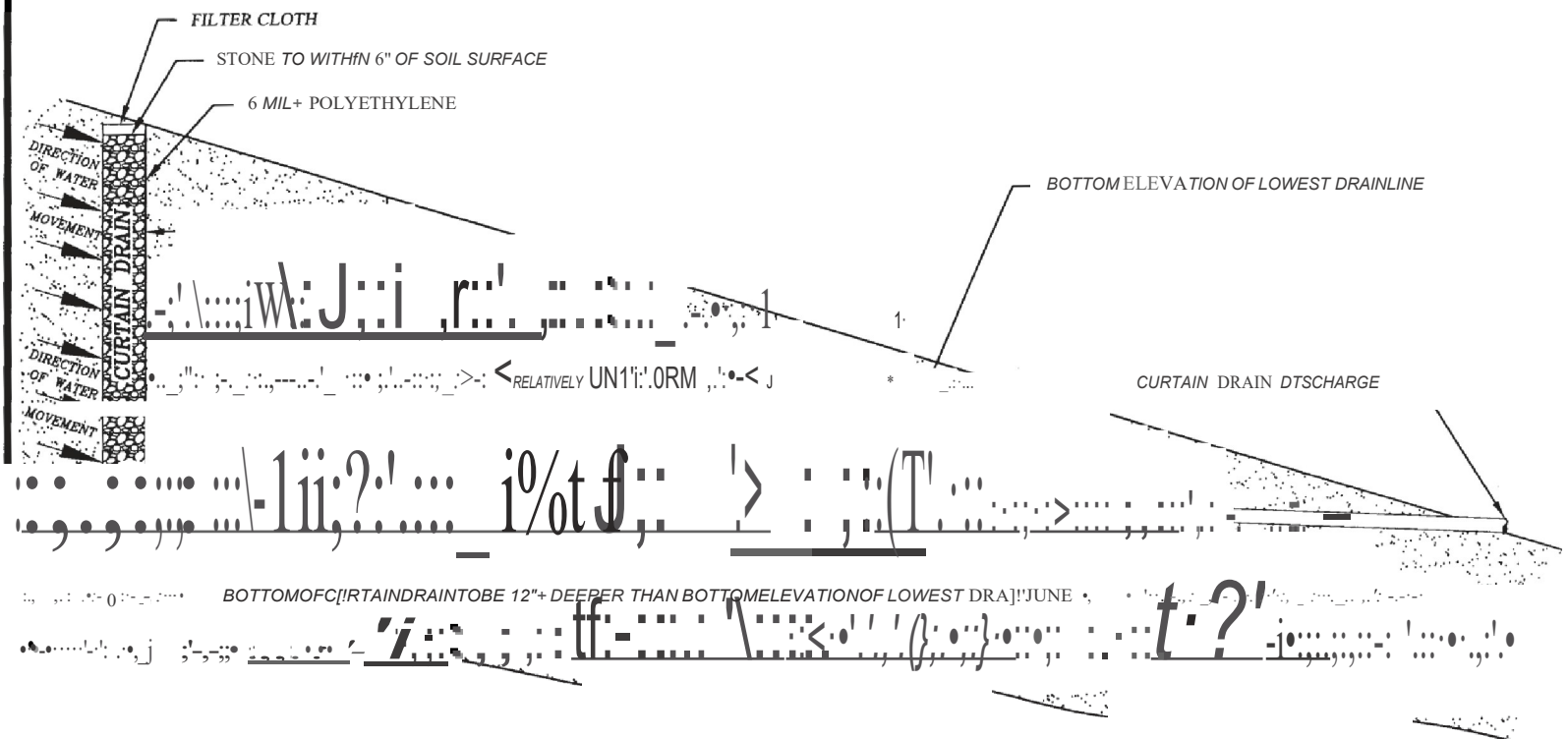

**CURTAIN DRAIN
SECTION A-A
DRAWING C**

Appendix S – Nonwater-Carried Sewage Treatment Systems

(1) The permitting of nonwater-carried sewage treatment systems, such as a biological, composting, or incinerating toilet, may be considered for toilet wastes when a proposed site is unsuitable for the issuance of an onsite wastewater system permit under the system standards in Appendices A through R. Nonwater-carried sewage treatment systems shall be designed, installed, maintained, and operated without endangering public health, the environment, or creating a nuisance.

(2) With the application for a permit to construct, all applicants seeking to install a nonwater-carried sewage treatment system must submit to the Department plans from a Registered Professional Engineer licensed in South Carolina that describe the design and installation of the proposed nonwater-carried sewage treatment system and demonstrate the following:

(a) The system complies with all local codes and ordinances.

(b) All products and processes meet applicable National Sanitation Foundation (NSF) Standards and American National Standards Institute (ANSI) Standard 41 and bear the seal of approval of the NSF or an equivalent testing and certification program.

(c) Compartment and appurtenances are insect and vector-proof and have continuous exterior ventilation.

(d) There will be no liquid wastewater produced by the system.

(e) Methods for training the owner/operator in the proper use, function, and maintenance of the system including safe handling and disposal methods for any residue generated by the system.

(f) All manufacturer recommendations for installation, operation, and maintenance will be followed.

(3) Applicants seeking to install a nonwater-carried sewage treatment system at a site where water under pressure will be connected to the structure and gray water is generated (from showers, sinks, etc.), but where nonwater-carried sewage treatment systems will be the only means for toilet waste disposal, must:

(a) Submit plans from a Registered Professional Engineer licensed in South Carolina that meet the requirements of Appendix S, paragraphs (2)(a) through (f), for all toilet wastes; and

(b) Apply for and obtain a Department permit to construct and approval to operate an onsite wastewater system for treatment of gray water. This system must meet all permit, licensing, and onsite wastewater system requirements under this regulation, except that the initial system size may be reduced by twenty-five (25) percent.

(4) A licensed installer is not required for the installation of a nonwater-carried sewage treatment system under this standard. However, engineering certifications using the applicable Department form must be submitted to the Department before the Department will issue an approval to operate a system under this standard.

Appendix T – Wastewater Combustion Systems

(1) Wastewater combustion systems may be considered when a proposed site is unsuitable for the issuance of an onsite wastewater system permit under the system standards in Appendices A through R. A

wastewater combustion system shall be designed, installed, maintained, and operated without endangering public health, the environment, or creating a nuisance.

(2) With the application for a permit to construct, all applicants seeking to install a wastewater combustion system must submit to the Department plans from a Registered Professional Engineer licensed in South Carolina that describe the design and installation of the proposed wastewater combustion system and demonstrate the following:

(a) The system complies with all local codes and ordinances.

(b) CSA Group certification of the wastewater combustion system in the United States.

(c) The system must be of adequate size to handle the wastewater volume and peak flow generated by the structure.

(d) Compartment and appurtenances are insect and vector-proof and have continuous exterior ventilation.

(e) All liquid wastewater produced must be sent to the combustion system. Liquid wastewater must not be sent to an onsite wastewater system or held in a storage system to be pumped and hauled.

(f) Methods for training the owner/operator in the proper use, function, and maintenance of the system including safe handling and disposal methods for any residue generated by the system.

(g) All manufacturer recommendations for installation, operation, and maintenance will be followed.

(3) Applicants seeking to install a wastewater combustion system for toilet wastes in conjunction with an onsite wastewater system for treatment of gray water generated by the structure must:

(a) Submit to the Department plans from a Registered Professional Engineer licensed in South Carolina that meet the requirements of Appendix T, paragraphs (2)(a) through (g), for all toilet wastes; and

(b) Apply for and obtain a Department permit to construct and approval to operate an onsite wastewater system for treatment of gray water. This system must meet all permit, licensing, and onsite wastewater system requirements under this regulation, except that the initial system size may be reduced by twenty-five (25) percent.

(4) A licensed installer is not required for the installation of a wastewater combustion system under this standard. However, engineering certifications using the applicable Department form must be submitted to the Department before the Department will issue an approval to operate a system under this standard.

Appendix U – Gray Water Subsurface Reuse Systems

(1) With the application for a permit to construct, all applicants seeking to install a gray water subsurface reuse system must submit to the Department for approval plans from a Registered Professional Engineer licensed in South Carolina that describe the design and installation of the proposed gray water subsurface reuse system and demonstrate the following:

(a) The system complies with all local codes and ordinances.

(b) The system must be of adequate size to handle the wastewater volume and peak flow generated by the structure.

(c) Compartment and appurtenances are insect and vector-proof and have continuous exterior ventilation.

(d) All gray water produced by the structure must be sent to the gray water subsurface reuse system or to a separate onsite wastewater system for treatment and disposal of domestic wastewater. Liquid wastewater must not be held in a storage system to be pumped and hauled.

(e) Methods for training the owner/operator in the proper use, function, and maintenance of the system including safe handling and disposal methods for any residue generated by the system.

(f) All manufacturer recommendations for installation, operation, and maintenance will be followed.

(2) This regulation does not apply to or permit the reuse of gray water for any purpose, or by any means, other than subsurface irrigation. This regulation also does not apply to or permit any reuse or recirculation of gray water within the confines of (i.e., via the plumbing within) a dwelling unit, building, business, or other structure.

(3) A property owner proposing to install a gray water subsurface reuse system for the reuse and disposal of gray water shall ensure that there is also an approved method of treatment and disposal for all other domestic wastewater and sewage generated by the structure. An onsite wastewater system for the treatment and disposal of all other domestic wastewater and sewage generated by the structure shall meet all requirements of this regulation, including standard sizing requirements.

(4) A licensed installer is not required for the installation of a gray water subsurface reuse system under this standard. However, engineering certifications using the applicable Department form must be submitted to the Department before the Department will issue an approval to operate a system under this standard.

500. Long-Term Acceptance Rate Standard for Onsite Wastewater Systems.

USDA-NRCS SOIL TEXTURE	SOIL CHARACTERISTICS WHEN MOIST (FIELD TEST)	LONG-TERM ACCEPTANCE RATE (GPD/SF)	
Sand (S)	Sand has a gritty feel, does not stain the fingers, and does not form ribbon or ball when wet or moist.	0.9 – 1.0	Class I
Loamy Sand (LS)	Loamy sand has a gritty feel, stains the fingers, forms a weak ball, and cannot be handled without breaking.		
Sandy Loam (SL)	Sandy loam has a gritty feel and forms a ball that can be picked up with the fingers and handled with care without breaking.	0.7 – 0.8	Class II
Loam (L)	Loam may have a slightly gritty feel but does not show a fingerprint, and forms only short ribbons from 0.25 – 0.50 inch. Loam will form a ball that can be handled without breaking.		
Sandy Clay Loam (SCL)	Sandy clay loam has a gritty feel but contains enough clay to form a firm ball and may ribbon from 0.75 – 1.0 inch.	0.5 – 0.6	Class III
Clay Loam (CL)	Clay loam is sticky when moist, forms a ribbon of 1.0 – 2.0 inches, and produces a slight sheen when rubbed with the thumbnail. Clay loam produces a nondistinct fingerprint.		

USDA-NRCS SOIL TEXTURE	SOIL CHARACTERISTICS WHEN MOIST (FIELD TEST)	LONG-TERM ACCEPTANCE RATE (GPD/SF)	
Silt Loam (SiL)	Silt loam has a floury feel when moist and will show a fingerprint, but will not ribbon and forms only a weak ball.		
Silt (Si)	Silt has a floury feel when moist and is sticky when wet but will not ribbon and forms a ball that will tolerate some handling.	0.1 – 0.4	Class IV
Silty Clay Loam (SiCL)	Silty clay loam has a slight floury feel, is sticky when moist, and will ribbon from 1.0 – 2.0 inches. Rubbing with thumbnail produces a moderate sheen. Silty clay loam produces a distinct fingerprint.		
Sandy Clay (SC)	Sandy clay is plastic, gritty, and sticky when moist, forms a firm ball, and produces a ribbon in excess of 2.0 inches.		
Clay (C)	Clay is both sticky and plastic when moist, produces a ribbon in excess of 2.0 inches, produces a high sheen when rubbed with the thumbnail, and forms a strong ball resistant to breaking.		
Silty Clay (SiC)	Silty clay has a slight floury feel, is both sticky and plastic when moist, forms a ball, and produces a ribbon in excess of 2.0 inches.		

(1) The long-term acceptance rate for system sizing shall be based upon the most hydraulically limiting naturally occurring soil texture from the ground surface to twelve (12) inches below the bottom of the proposed wastewater infiltration trenches. Alternative and experimental systems installed beneath expansive soils shall be sized at a long-term acceptance rate not to exceed 0.2-0.25 gpd/sf as specified in approved standards.

(2) Soil texture shall be estimated by field testing as described above. Laboratory determination of soil texture may be substituted for field testing when conducted in accordance with: (1) Bouyoucos, G.J. 1962. Hydrometer Method Improved for Making Particle Size Analyses of Soils. Agron. J. 53:464-465; (2) ASTM D-422, Procedures for Sieve and Hydrometer Analyses; or (3) the Pipette Method (ASA-CSSA-SSSA), USDA Methods of Soils Analysis, Soil Survey Laboratory Information Manual, and Soil Survey Laboratory Methods Manual.

(3) The total linear feet (lf) for conventional onsite wastewater systems shall be calculated by dividing the peak daily flow (gpd) by the long-term acceptance rate (gpd/sf) and dividing the result by the trench width (ft): $lf = \text{gpd} \div \text{gpd/sf} \div \text{ft}$. The total linear feet for alternative systems may either be increased or decreased in accordance with factors specified in alternative standards.

501. Peak Sewage Flow Rate Standard.

ESTABLISHMENT	UNIT	PEAK FLOW RATE GAL/UNIT/DAY
Airport (Not Including Food Service)	Passenger	3
Assembly Halls	Person	3
Bar (Not Including Food Service)	Customer	5
	Seat	15
Beauty/Style Shops/Barber Shops	Chair	100

ESTABLISHMENT	UNIT	PEAK FLOW RATE GAL/UNIT/DAY
Businesses/Offices/Factories	Employee/Shift	15
	Transient Employee (4 hrs or Less/Shift)	10
(Add for Showers)	Employee	10
Camps (No Laundry)		
-Labor/Summer/Retreat	Person	35
(Separate Food Service)	Person	10
(Separate Bath House)	Person	25
-Day Camps (with meal)	Person	15
(without meal)	Person	10
Campgrounds (No Laundry)		
-Full Water/Sewer	Campsite	120
-No Sewer Risers, Bathhouse only	Campsite	50
(Add for Dump Station)	Campsite	40
Car Wash (Non-automatic)	Bay	500
Church (No Daycare)		
-With Kitchen	Seat	3
-Without Kitchen	Seat	2
-Family Life Center	Person	5
Day Care	Child	10
Food Service		
-Full Service Utensils	Meal	4
	Person	10
	Seat	40
-Paper/Plastic Utensils		Reduce by 50 percent
Golf Course Club House (Not Including Foodservice)	Player	10
Kennel	Run	25
Laundromat	Machine	500
Mortuary (for domestic wastewater only, no infectious waste)	Body	25
Hotel/Motel (Not Including Food Service)	Room	100
Picnic Park	Visitor	10
Public Restroom	User	3
Residential/Dwelling	Bedroom	120
Residential Care	Resident	100
Residential Out-Building (not used as a dwelling; e.g., pool house, private workshop or garage with private-use bathroom with toilet and sink; barn with hand-wash sink)	1 to 3 Users	
	Without washing machine	60
	With washing machine/shower	120

ESTABLISHMENT	UNIT	PEAK FLOW RATE GAL/UNIT/DAY
School		
-With Cafeteria, Gym & Showers	Student	15
-With Cafeteria only	Student	10
-Without Cafeteria, Gym or Showers	Student	8
-Boarding School	Person	60
Stadium (Not Including Food Service)	Seat/Occupancy	3
Swimming Area Bathhouse	Person	10
Visitor Center	Visitor	5

The peak flow rate (gpd) for non-residential facilities may either be increased or reduced when comparable peak water consumption data for similar establishments in similar locations vary from the requirement. When considering such data, at least twelve (12) consecutive months must be presented with the maximum month of consumption and the days of operation per month being utilized to arrive at the peak flow rate (gpd).

502. Onsite Wastewater Pump System Standard.

502.1. Pump Tank (General).

(1) The submersible sewage effluent pump(s) must be housed in a properly vented, watertight tank that is readily accessible from the surface.

(2) A watertight access opening with removable lid shall be provided and shall be designed and maintained to prevent surface water inflow. Risers and other pump tank sections, where present, shall be joined using mastic, butyl rubber, or other pliable sealant that is waterproof, corrosion-resistant, and approved for use in septic tanks.

(3) When the pump tank must be located in an area characterized by a shallow zone of saturation, the Department may require the use of a pre-cast manhole, a fiberglass or polyethylene basin, or any other acceptable method for preventing groundwater intrusion.

(4) When the pump tank must be located in an area that is environmentally sensitive or subject to flooding, applicable portions of R.61-67, Standards for Wastewater Facility Construction, shall apply.

(5) The pump tank shall have sufficient capacity to accommodate all level control and alarm switches; to keep the pump(s) totally submersed in liquid at all times and to provide the required dosing volume and minimum pump run time. Pump tank capacity must be at least 500 gallons in order to provide emergency storage in the event of pump or power failure and to assist in maintaining the minimum pumping rate as listed in Section 502.2.

(6) Pre-engineered, manufactured packaged pump stations can be utilized in lieu of the composite design described herein, provided the pump meets the minimum capacity requirements of the system and no alterations are made to the pump station other than those specifically authorized by the manufacturer.

502.2. Minimum Pumping Rates (Peak Inflow) and Minimum Run Times.

(1) For residential systems, the maximum daily flow entering the pump tank shall be based upon one hundred twenty (120) gpd per bedroom. For commercial and other facilities, this value shall be based upon Section 501, Peak Sewage Flow Rate Standard.

(2) The minimum pumping rate (peak inflow) for discharges up to fifteen hundred (1500) gpd shall be determined as follows:

<u>Maximum Estimated Daily Flow (gpd)</u>	<u>Minimum Pumping Rate (peak inflow) (gpm)</u>
480 and less	10
481 - 720	15
721 - 1500	20

(3) The minimum pumping rate (peak inflow) for discharges in excess of fifteen hundred (1500) gpd shall be determined by multiplying the average flow rate (gpm) times a peaking factor of not less than 2.5, where the average flow rate is based upon actual minutes per day of facility operation.

(4) The minimum pump run time for all pump systems shall be determined as follows:

<u>Minimum Pumping Rate (peak inflow) (gpm)</u>	<u>Minimum Pump Run time (min)</u>
10 - 14	3
15 - 24	4
25 and above	5

502.3. Minimum Dosing Volume, Scouring Velocity, and Pump Capacity.

(1) The minimum dosing volume (gal) shall be determined by multiplying the minimum pumping rate (gpm) times the minimum pump run time (min).

(2) The selected pump(s) must have the capacity to deliver the minimum pumping rate (gpm) at a scouring velocity of at least one (1) ft/sec (effluent) or two (2) ft/sec (raw) against the total dynamic head of the system. This minimum pump capacity (gpm at total feet of dynamic head) shall be specified on the permit to construct.

(3) Duplex pumps shall be required when the maximum estimated daily flow is equal to or greater than fifteen hundred (1500) gallons, and each pump shall meet the minimum capacity as stated above.

(4) In those cases where the minimum pump capacity or any other system requirements exceed what can be specified through the use of this Standard, the Department shall require the applicant to retain the services of a Registered Professional Engineer licensed in South Carolina.

502.4. Force Main, Valves, and Fittings.

(1) The force main shall be Schedule 40 PVC, and the diameter shall be sufficient to provide a velocity of at least one (1) ft/sec (effluent) or two (2) ft/sec (raw) using a C Factor of one hundred fifty (150) (effluent) or one hundred forty (140) (raw) at the minimum pumping rate (peak inflow). The force main shall be installed a minimum of eight (8) inches below the ground surface. Fittings and valves shall be of compatible corrosion resistant material.

(2) A threaded union, flange, or similar disconnect device shall be provided in each pump discharge line. The pump(s) shall be easily removable at ground surface without requiring entrance into the tank. Valves shall also be readily accessible from the ground surface. Duplex pump systems shall be equipped with a separate pit or box for the placement and operation of valves.

(3) A shutoff valve (e.g., gate valve) and a check valve shall be located on the discharge line from each pump. The check valve shall be placed between the pump and the shutoff valve.

(4) A three-sixteenths (3/16) inch anti-siphon hole(s) shall be placed between the pump(s) and the check valve(s) when the discharge elevation of the distribution system is below the inlet to the pump tank.

(5) In cases where the force main must be installed over undulating terrain, automatic air relief valves shall be placed at high points in the line to prevent air locking.

(6) Exposed force mains crossing ditches and bodies of water (e.g., creeks and wetlands) and force mains under driveways and parking areas must be protected by encasing them within a larger diameter pipe that can withstand potential damage (e.g., galvanized pipe, steel pipe, ductile iron). Force mains under driveways and parking areas may also be protected by encasing them within a larger diameter schedule 80 PVC pipe. The protective piping should extend beyond the area of needed protection for at least ten (10) linear feet.

(7) The force main effluent shall discharge into a separate discharge box or distribution manifold before entering either a septic tank or a soil wastewater infiltration trench. The flow shall be directed to the bottom of the box through a PVC elbow or into a distribution manifold at an angle of ninety (90) degrees to the septic tank or first wastewater infiltration trench.

502.5. Pumps, Control Devices, and Electrical Connections.

(1) Pumps shall be listed by Underwriter's Laboratory or an equivalent third-party testing and listing agency and shall be specifically manufactured for use with domestic wastewater.

(2) Sealed mercury control floats or similar devices designed for detecting liquid levels in septic tank effluent shall be provided to control pump cycles. A separate level sensing device shall be provided to activate an audible and visible high water alarm. Pump-off levels shall be set to keep the pump submerged at all times.

(3) Pump and control circuits shall be provided with manual circuit disconnects within a watertight, corrosion resistant, outside enclosure (NEMA 4X or equivalent) adjacent to the pump tank, securely mounted at least twelve (12) inches above finished grade, unless installed within a weather-tight building. Alarm circuits shall be supplied ahead of any pump overload or short circuit protective devices. The pump(s) shall be manually operable without requiring special tools or entrance into the tank for testing purposes. Conductors shall be conveyed to the disconnect enclosure through water proof, gas proof, and corrosion resistant conduit(s) with no splices or junction boxes provided inside the tank. Wire grips, duct seal, or other suitable material shall be used to seal around wire and wire conduit openings inside the pump tank and disconnect enclosure.

(4) For systems requiring duplex pumps, each pump shall operate in a lead-lag sequence and be on an alternating cycle. A control panel shall be provided which shall include short circuit protection for each pump and for the control system, independent disconnects, automatic pump sequencer, hands-off-automatic (H-O-A) switches, run lights, and elapsed time counters for each pump.

502.6. Final Inspection and Approval.

(1) Before or during final inspection, the property owner or agent shall provide literature, including a pump curve, describing the specific pump installed. The inspector shall evaluate the system in accordance with this Standard, and shall confirm that all items, including the minimum pump capacity specified on the permit to construct, have been satisfied.

(2) Prior to final approval, the installer or electrician shall provide the Department with written documentation verifying that pump system electrical connections were made in accordance with all applicable codes. The Department may require testing of the pump system, demonstration of watertight integrity, or any other procedure deemed necessary to confirm the acceptability of the installation.

502.7. Raw Sewage Pump Stations.

(1) In those cases where it is necessary to pump raw sewage from a residence or facility to an onsite wastewater system, the pump station shall meet all applicable portions of this Standard and R.61-67, Standards for Wastewater Facility Construction.

(2) Adherence to the pump manufacturer's recommendations shall also be a major consideration with such systems.

503. Minimum Design Standards for Tank Construction.

503.1. Introduction.

The following standards describing tank designs intended to be utilized for septic tanks, grease traps, or pump chambers for onsite wastewater systems have been adopted in an effort to assure a quality product of sufficient strength and resistance, capable of fulfilling its intended purpose.

503.2. Design Approval.

(1) No person shall manufacture tanks intended to be utilized for septic tanks, grease traps, or pump chambers for onsite wastewater systems without receiving approval from the Department. All manufactured tanks must receive approval of design and reinforcement methods prior to manufacturing.

(2) Any person desiring to manufacture tanks shall submit a written application on forms provided by the Department. Such application shall include the name and address, the location of the facility, tank capacity, and design information.

(3) Prior to approval, the Department shall review the tank design, reinforcement, and manufacturing methods to determine compliance.

(4) The Department shall approve plans for manufactured tanks to ensure compliance with the South Carolina Minimum Design Standards for Tank Construction.

(5) The Department shall approve plans for fabricated tanks, other than those for precast reinforced concrete tanks, on an individual basis. Fabricated tanks shall meet the requirements of precast reinforced concrete tanks to provide equivalent effectiveness.

(6) The Department shall issue an approval to the tank manufacturer if the tank design, reinforcement and manufacturing method complies with the South Carolina Minimum Design Standards for Tank Construction. Tank manufacturing approvals are not transferable. When a change of ownership occurs, the new owner shall submit a written application on forms provided by the Department.

(7) The Department shall revoke approval to manufacture tanks for onsite wastewater systems if the tank manufacturer fails to comply with the South Carolina Minimum Design Standards for Tank Construction.

503.3. General.

(1) Septic tanks and grease traps shall be manufactured as single compartment or partitioned tanks.

(2) If septic tanks and grease traps are manufactured with a partition so that the tank contains two (2) compartments, the inlet compartment of the tank shall contain two-thirds ($2/3$) of the overall capacity, and the outlet compartment shall contain one-third ($1/3$) of the overall capacity. The top of the partition shall terminate two (2) inches below the bottom side of the tank top in order to leave space for air or gas passage between compartments. The top and bottom halves of the partition shall be constructed in such manner as to leave a four (4) inch water passage at the vertical mid-point of the partition wall for the full width of the tank.

(3) The minimum liquid capacity requirements shall be met by the use of a single septic tank or two (2) or more tanks installed in series. Septic tanks joined in series shall be interconnected by an upper effluent pipe(s) with a minimum diameter of four (4) inches and a lower sludge pipe(s) with a minimum diameter of twelve (12) inches. The upper connection(s) shall be installed level from tank to tank, and the lower sludge pipe connection(s) shall be installed level and shall be placed twelve (12) inches above the bottoms of the tanks. The lower sludge pipe connection(s) can be eliminated if the first tank in series contains at least two-thirds ($2/3$) of the total required liquid capacity. There shall be no more than two (2) inches of fall from the inlet invert of the first tank to the outlet invert of the last tank in series.

(4) It is required that all pump chambers function as a single compartment tank. If a two (2) compartment tank is used, at least two (2) six (6) inch diameter holes or equivalent, must be provided in the partition wall six (6) inches from the tank bottom.

(5) The septic tank and grease trap tank length shall be at least two (2) but not more than three (3) times the width.

(6) The liquid depth shall not be less than four (4) feet.

(7) A minimum of nine (9) inches of freeboard shall be provided in all tanks, unless otherwise approved by the Department.

(8) Useable liquid capacity for septic tanks or grease traps shall not be less than one thousand (1000) gallons.

(9) The pump tank shall have sufficient capacity to accommodate all level control and alarm switches; to keep the pump(s) totally submersed in liquid at all times and to provide the required dosing volume and minimum pump run time. It is strongly recommended that pump tank capacities be as large as possible in order to provide emergency storage in the event of pump or power failure.

(10) There shall be a minimum of two (2) openings in the tank wall located at the inlet and outlet ends or sides of the inlet and outlet ends of the tank. The knockouts for the inlet and outlet openings of pre-cast concrete tanks shall have a concrete thickness of not less than one (1) inch in the tank wall. The openings shall allow for a minimum of four (4) inch pipe or a maximum of six (6) inch pipe. No openings shall be permitted below the tank liquid level.

(11) The inlet and outlet for septic tanks and grease traps shall be a cast-in-place concrete tee, a polyvinyl chloride (PVC) tee, an acrylonitrile butadiene styrene (ABS), or a polyethylene (PE) tee made of not less than Schedule 40 pipe or equivalent fittings and material. The cast-in-place concrete tees shall have a minimum thickness of not less than two (2) inches. The invert of the outlet shall be at least two (2) inches lower in elevation than the invert of the inlet. The inlet and outlet tees shall extend above liquid level a minimum of six (6) inches and to no less than one (1) inch from the top of the tank to allow venting between tank compartments and multiple tank configurations.

(12) The inlet tee for septic tanks and grease traps shall extend sixteen (16) inches below the liquid level.

(13) The outlet tee for a septic tank shall extend eighteen (18) inches below the liquid level and the outlet tee for a grease trap shall extend between six (6) and twelve (12) inches above the tank bottom.

(14) The inlet, outlet, and wiring conduit openings of all tanks must utilize a resilient, watertight, non-corrosive connective sleeve. The use of grout is prohibited.

(15) Access to each tank or compartment shall be provided by an opening located above the inlet and outlet with an inside dimension of at least eighteen (18) inches square (18 x 18) or in diameter, with removable tank access lids.

(16) Concrete tank access lids shall be equipped with steel lift rings at least three-eighths (3/8) inch diameter or by an alternative method approved by the Department.

(17) Should risers or manholes be utilized to allow access into septic tanks, grease traps, or pump chambers, the risers or manhole covers, as applicable, shall be constructed to prevent the release of odors, entry of vectors, and water. Grade level riser/manhole covers shall be secured by bolts, locking mechanisms, fasteners that can only be removed by tools, or have sufficient weight to prevent unauthorized access. The ground shall slope away from any access extended to grade level.

(18) Risers/manholes shall be sealed to the tank by using bituminous mastic, butyl rubber, or other pliable sealant that is waterproof, corrosion-resistant, and approved for use in tank construction. The sealant shall have a minimum size of one (1) inch diameter or equivalent. The joint shall be smooth, intact, and free of all deleterious substances before sealing.

(19) After curing, all multi-piece tanks shall be joined and sealed at the joints by using a bituminous mastic, butyl rubber, or other pliable sealant that is waterproof, corrosion-resistant, and approved for use in tank construction. The sealant shall have a minimum size of one (1) inch diameter or equivalent. The joint shall be smooth, intact, and free of all deleterious substances before sealing. The use of grout is prohibited.

(20) All concrete tanks must pass the ASTM C-1227 Standard for watertight testing. The Department will choose tanks at random for testing. Tanks will be approved for use in South Carolina after the Department ascertains that the standard is met. After joining, tanks manufactured in multiple sections shall be plastered along the section joints with hydraulic cement or other waterproofing sealant. Other methods of waterproofing tanks may be used as specifically approved in the plans and specifications for the tank. Prior to backfilling, the Department shall make a finding that multiple section tanks are watertight if a soil

wetness condition is present within five feet of the elevation of the top of the tank. Any tank found to be improperly sealed, having cracks or holes, which will allow for water infiltration or discharge of sewage from the tank bottom, walls, or top, will not be approved for use.

(21) Concrete tank manufacturers must have equipment and capabilities for portion control to maintain constant mixture formulation ratios and provide for systematic inspection of finished products to ensure compliance with the minimum tank construction and design standards.

(22) The concrete mix used for concrete tank components must be formulated to yield a minimum twenty-eight (28) day compressive strength of four thousand (4,000) pounds per square inch (psi).

(23) The aggregate size utilized in the concrete mix shall not exceed one-third (1/3) of the wall thickness. Suitable aggregates include sand particle sizes from a fine to one-fourth (1/4) inch gravel or crushed stone. Granite dust or fine screenings from a crusher operation may be used in lieu of sand.

(24) An identifying seal must be cast, molded, or permanently affixed by an approved method from the Department on the outlet tank wall within six (6) inches of the top. The identifying seal shall identify the manufacturer and the liquid capacity of the tank. The concrete tank's cast date shall be located on the identifying seal or imprinted on the top of the tank within six (6) inches from outlet tank wall near the identifying seal. The lettering on the identifying seal or date imprinted on the top of the tank shall be no more than six (6) inches in height.

(25) The tank manufacturer shall guarantee all tanks in writing for two (2) years against failure due to poor workmanship and materials.

(26) Changes in approved tank design, construction, and alternative reinforcing methods will not be allowed without prior approval from the Department.

503.4. Pre-Cast Concrete Non-Fiber Reinforced Septic Tanks and Grease Traps.

(1) The tank walls and bottom shall be reinforced with six by six (6 x 6) inch ten (10) gauge wire mesh.

(2) Tank tops shall be reinforced with six by six (6 x 6) inch ten (10) gauge wire mesh, a minimum of five (5) sections of three-eighths (3/8) inch diameter steel reinforcing bars oriented perpendicular to the tank sidewalls beginning at the center spaced twelve (12) inches apart and four (4) sections of three-eighths (3/8) inch diameter steel reinforcing bars placed diagonally from the corners to the center of the tank. The length of the perpendicular reinforcing bars shall be of sufficient length to extend two (2) inches into the sidewall. The length of the four (4) diagonal steel reinforcing bars shall be of sufficient length to extend two (2) inches into the sidewall and six (6) inches beyond the closest perpendicular steel reinforcing bar.

(3) If a septic tank or grease trap is manufactured with a partition, the tank partition (both halves) shall be reinforced with six by six (6 x 6) inch ten (10) gauge wire mesh. The reinforcing wire shall be bent to form an angle of ninety (90) degrees on the ends in order to form a leg not less than four (4) inches long. When the wire is placed in the mold, the four-inch legs shall lay parallel with the sidewall wire and adjacent to it.

(4) The tank walls and bottom thickness shall be at least two and one-half (2½) inches, and top thickness shall be at least three (3) inches.

(5) All reinforcing wire and rods must be covered by at least one-half (1/2) inch of concrete.

(6) An acceptable vibration method shall be employed in the construction of the tank to prevent voids in the tank walls, bottom, and top.

503.5. Pre-Cast Concrete Fiber Reinforced Septic Tanks and Grease Traps.

(1) Tank tops shall be reinforced with a minimum of five (5) sections of three-eighths (3/8) inch diameter steel reinforcing bars oriented perpendicular to the tank sidewalls beginning at the center spaced twelve (12) inches apart, and four (4) sections of three-eighths (3/8) inch diameter steel reinforcing bars placed diagonally from the corners to the center of the tank. The length of the perpendicular reinforcing bars shall be of sufficient length to extend two (2) inches into the sidewall. The length of the four (4) diagonal steel reinforcing bars shall be of sufficient length to extend two (2) inches into the sidewall and six (6) inches beyond the closest perpendicular steel reinforcing bar.

(2) Tank bottoms shall be reinforced with a minimum of seven (7) sections of three-eighths (3/8) inch diameter steel reinforcing bars oriented perpendicular to the tank sidewalls beginning at the center spaced twelve (12) inches apart. The length of the perpendicular reinforcing bars shall be of sufficient length to extend two (2) inches into the sidewall.

(3) If a septic tank or grease trap is manufactured with a partition, the tank partition (both halves) shall be reinforced with six by six (6 x 6) inch ten (10) gauge wire mesh. The reinforcing wire shall be bent to form an angle of ninety (90) degrees on the ends in order to form a leg not less than four (4) inches long. When the wire is placed in the mold, the four-inch legs shall lay parallel with the sidewall wire and adjacent to it.

(4) The tank perimeter walls shall be reinforced with three-eighths (3/8) inch diameter steel reinforcing bars located one (1) inch from the tank's top and bottom section seams.

(5) The tank walls and bottom thickness shall be at least two and one-half (2½) inches, and top thickness shall be at least three (3) inches.

(6) All reinforcing wire and rods must be covered by at least one-half (1/2) inch of concrete.

(7) Fiber products used with this reinforcement design must be added during the mixing process in order to achieve even distribution throughout the concrete mixture.

(8) Fiber length must range from at least one (1) to no more than two (2) inches.

(9) The fiber must be specifically manufactured for use as a concrete secondary reinforcement and be a polypropylene fibrillated (two-dimensional fiber mesh network) material.

(10) An acceptable vibration method shall be employed in the construction of the tank to prevent voids in the tank walls, bottom, and top.

503.6. Concrete Block Septic Tanks and Grease Traps.

(1) The tank walls and partition thickness shall be at least eight (8) inches and the top cover slabs thickness shall be at least four (4) inches.

(2) The tank bottom shall be a single pour concrete slab to a depth of at least four (4) inches within the first block course.

(3) If a septic tank or grease trap is manufactured with a partition, the tank walls and partition shall be constructed of solid sixteen by eight by eight (16 x 8 x 8) inch concrete blocks. The use of hollow blocks is prohibited.

(4) All joints between concrete blocks shall be mortared using masonry cement mortar or equivalent. The joints shall have a nominal thickness of three-eighths (3/8) inch.

(5) The upper partition wall may be supported by the use of two by four by eight (2 x 4 x 8) inch bricks (or equivalent support material) standing on edge located at the block seams of the upper partition wall.

(6) The top cover slabs shall be constructed such that the individual slabs will not exceed two (2) feet in width and the length will be sufficient to extend to the outside tank width with a minimum slab thickness of four (4) inches.

(7) The individual top cover slabs shall be reinforced with a minimum of two (2) sections of three-eighths (3/8) inch diameter steel reinforcing bars oriented perpendicular to the tank sidewalls spaced twelve (12) inches apart from the center. The length of the perpendicular reinforcing bars shall be of sufficient length to extend the full length of the slab.

(8) The end cover slabs shall be constructed such that the individual slabs will not exceed three (3) feet in width and the length will be sufficient to extend to the outside tank width with a minimum slab thickness of four (4) inches.

(9) The end cover slabs shall be cast to allow access to each tank or compartment by providing an opening located above the inlet and outlet tee with an inside dimension of eighteen (18) inches square (18 x 18 inches) or in diameter with removable tank access lids.

(10) The individual end cover slabs shall be reinforced with two (2) sections of three-eighths (3/8) inch diameter steel reinforcing bars oriented perpendicular to the tank sidewalls spaced twelve (12) inches apart from the center and two (2) sections of three-eighths (3/8) inch diameter steel reinforcing bars oriented perpendicular to the tank sidewalls spaced sixteen (16) inches apart from the center. The length of the perpendicular reinforcing bars shall be of sufficient length to extend the full length of the slab.

(11) The top and end cover slab seams shall be sealed to the tank walls and at all joints by using a bituminous mastic, butyl rubber, or other pliable sealant that is waterproof, corrosion-resistant, and approved for use in septic tanks. The sealant shall have a minimum size of one (1) inch diameter or equivalent. The use of grout is prohibited.

(12) The tank top and end cover slabs shall be equipped with steel lift handles at least one half (1/2) inch diameter, or by an alternative method approved by the Department.

(13) All reinforcing rods must be covered by at least one-half (1/2) inch of concrete.

(14) The interior of the tank (walls and bottom) shall be plastered with a waterproofing cement compound.

(15) An acceptable vibration method shall be employed in the construction of the tank to prevent voids in the tank access lids, tank bottom, and top and end slabs.

503.7. Pre-Cast Concrete Non-Fiber Reinforced Pump Chambers.

- (1) The tank walls and bottom shall be reinforced with six by six (6 x 6) inch ten (10) gauge wire mesh.
- (2) Tank tops shall be reinforced with six by six (6 x 6) inch ten (10) gauge wire mesh, a minimum of five (5) sections of three-eighths (3/8) inch diameter steel reinforcing bars oriented perpendicular to the tank sidewalls beginning at the center spaced twelve (12) inches apart, and four (4) sections of three-eighths (3/8) inch diameter steel reinforcing bars placed diagonally from the corners to the center of the tank. The length of the perpendicular reinforcing bars shall be of sufficient length to extend two (2) inches into the sidewall. The length of the four (4) diagonal steel reinforcing bars shall be of sufficient length to extend two (2) inches into the sidewall and six (6) inches beyond the closest perpendicular steel reinforcing bar.
- (3) The tank walls and bottom thickness shall be at least two and one-half (2½) inches, and top thickness shall be at least three (3) inches.
- (4) All reinforcing wire and rods must be covered by at least one-half (1/2) inch of concrete.
- (5) An acceptable vibration method shall be employed in the construction of the tank to prevent voids in the tank walls, bottom, and top.

503.8. Pre-Cast Concrete Fiber Reinforced Pump Chambers.

- (1) Tank tops shall be reinforced with a minimum of five (5) sections of three-eighths (3/8) inch diameter steel reinforcing bars oriented perpendicular to the tank sidewalls beginning at the center spaced twelve (12) inches apart and four (4) sections of three-eighths (3/8) inch diameter steel reinforcing bars placed diagonally from the corners to the center of the tank. The length of the perpendicular reinforcing bars shall be of sufficient length to extend two (2) inches into the sidewall. The length of the four (4) diagonal steel reinforcing bars shall be of sufficient length to extend two (2) inches into the sidewall and six (6) inches beyond the closest perpendicular steel reinforcing bar.
- (2) Tank bottoms shall be reinforced with a minimum of seven (7) sections of three-eighths (3/8) inch diameter steel reinforcing bars oriented perpendicular to the tank sidewalls beginning at the center spaced twelve (12) inches apart. The length of the perpendicular reinforcing bars shall be of sufficient length to extend two (2) inches into the sidewall.
- (3) The tank perimeter walls shall be reinforced with three-eighths (3/8) inch diameter steel reinforcing bars located one (1) inch from the tank's top and bottom section seams.
- (4) The tank walls and bottom thickness shall be at least two and one-half (2½) inches, and top thickness shall be at least three (3) inches.
- (5) All reinforcing wire and rods must be covered by at least one-half (1/2) inch of concrete.
- (6) Fiber products used with this reinforcement design must be added during the mixing process in order to achieve even distribution throughout the concrete mixture.
- (7) Fiber length must range from at least one (1) to no more than two (2) inches.
- (8) The fiber must be specifically manufactured for use as a concrete secondary reinforcement and be a polypropylene fibrillated (two-dimensional fiber mesh network) material.

(9) An acceptable vibration method shall be employed in the construction of the tank to prevent voids in the tank walls, bottom, and top.

504. Fiberglass Reinforced Plastic Tanks Standard.

Standards describing fiberglass reinforced plastic septic tanks have been adopted to ensure a quality product of sufficient strength and resistance, capable of fulfilling its intended purpose. Many of these standards were derived from NBS Voluntary Product Standard PS 15-69, which covers custom contact-molded reinforced polyester chemical resistant process equipment.

504.1. General Requirements.

The following general requirements are applicable to fiberglass reinforced plastic septic tanks as defined within this regulation, and approved design standards and structural properties of the same shall be not less than those stated.

(1) Material

Resins and sealants used in the tank manufacturing process shall be capable of effectively resisting corrosive influences of liquid components of sewage, gases generated by the digestion of sewage, and soil burial. Materials used shall be formulated to withstand vibration, shock, normal household chemicals, earth, and hydrostatic pressure both when full and empty. Not less than thirty (30) percent of the total weight of the tank shall be fiberglass reinforcement. For tanks not exceeding a fifteen hundred (1500) gallon liquid capacity, the minimum wall thickness shall be three-sixteenths (3/16) inch, provided, however, that isolated small spots may be as thin as eighty (80) percent of the minimum.

(2) Inner Coating

Internal surfaces shall be coated with an appropriate gel coating to provide a smooth, pore-free, watertight surface for fiberglass reinforced plastic parts.

(3) Physical Properties

Tanks shall be so constructed that all parts of the tank shall meet the following requirements:

(a) Ultimate Tensile Strength (Minimum) – Nine thousand (9,000) pounds per square inch (psi) when tested in accordance with ASTM D 638-71a, Standard Method of Test for Tensile Properties of Plastics.

(b) Flexural Strength (Minimum) – Sixteen thousand (16,000) psi when tested in accordance with ASTM D 790-71, Standard Method of Test for Flexural Properties of Plastics.

(c) Flexural Modulus of Elasticity Tangent (Minimum) – Seven hundred thousand (700,000) psi when tested in accordance with ASTM D 790-71, Standard Method of Test for Flexural Properties of Plastics.

(4) Watertight Integrity

Tanks shall be so constructed as to be watertight for the designed life of the tank. Lids or covers shall be sufficiently tight when installed to preclude the entrance of surface or ground water into the tank.

(5) Longevity

Proof from an independent testing laboratory shall be submitted substantiating a minimum life expectancy of twenty years of service for the intended use of the tank and appurtenant components such as necessary sealants, connective fastenings, resins, etc.

(6) Safety

As a safety measure, provisions shall be made in the construction of septic tank lids or covers to preclude unauthorized entry or removal when the use of the tank necessitates positioning of access openings at or above ground level.

(7) Workmanship

Tanks shall be of uniform thickness and free from defects that may affect their serviceability or durability. Completed tanks shall have a smooth inside finish free of spills, pits, and honeycombs. Plant quality control shall be sufficient to maintain a high degree of uniformity in tank quality.

504.2. Specific Requirements.

Specific requirements for design and construction shall be not less than those specified herein and shall be in conformity with recognized National Standards for design and construction and in accordance with this regulation.

504.3. Capacity and Design Limits.

(1) Dimensions

(a) The inside length of a horizontal cylindrical tank shall be at least two (2) but not more than three (3) times the width.

(b) The uniform liquid depth shall not be less than four (4) feet.

(c) At least fifteen (15) percent of the total volume of the tank shall be above the liquid level.

(d) If tanks of other shapes are proposed, specifications must be submitted to the Department for approval.

(2) Inlet

(a) Provisions shall be made for the building sewer to enter the center of one end of the septic tank two (2) inches above the normal liquid level of the tank.

(b) A tee shall be constructed as an integral part of the tank to receive the building sewer, or as an alternative, an integrally constructed baffle may be used.

(c) If baffles are used, suitable integrally fitted sleeves or collars shall be provided in the inlet openings of the tank to provide surface areas sufficient to ensure capability of watertight bonding between the tank and the inlet sewer.

(d) If the tee or baffle is constructed of plastic material, it shall meet NSF Standard #14 for drain, waste, and vent system application.

(e) If fiberglass reinforced plastic is used, it shall be of the same constituency as material of which the tank is constructed.

(f) The inlet tee or baffle shall extend sixteen (16) inches below the designed liquid level and be placed and secured in a vertical position so as to be watertight and preclude dislodgement during installation, operation, or maintenance activities.

(3) Outlet

(a) Provisions shall be made for the outlet sewer to receive the discharge from the tank by providing an opening in the center of the end of the tank opposite the inlet, the invert elevation of which shall be at the liquid level of the tank.

(b) A tee shall be constructed as an integral part of the tank to connect to the outlet sewer or, as an alternative, an integrally constructed baffle may be used.

(c) If baffles are used, suitable integrally fitted sleeves or collars shall be provided in the outlet opening of the tank to provide surface areas sufficient to ensure capability of water-tight bonding between the tank and the outlet sewer.

(d) If the tee or baffle is constructed of plastic material, it shall meet NSF Standard #14 for drain, waste, and vent system application.

(e) If fiberglass reinforced plastic is used, it shall be of the same constituency as material of which the tank is constructed.

(f) The outlet tee or baffle shall extend eighteen inches below the design liquid level and be placed and secured in a vertical position so as to be watertight and preclude dislodgement during installation, operation, or maintenance activities.

(g) The inlet and outlet tees shall extend above liquid level a minimum of six (6) inches and to no less than one (1) inch from the top of the tank to allow venting between tank compartments and multiple tank configurations.

(4) Access Openings

Openings in the top of the septic tank shall be provided over the inlet and outlet tees or baffles with sufficient area to enable maintenance service to such tees or baffles.

(5) Identifying Markings

Fiberglass septic tanks shall be provided with a suitable legend, cast or stamped into the wall at the outlet end, and within six inches of the top of the tank, identifying the manufacturer, and indicating the liquid capacity of the tank in gallons.

505. Thermoplastic Tanks Standard.

(1) The Department shall approve plans for thermoplastic tanks on an individual basis.

(a) Thermoplastic tanks shall be certified by an American National Standards Institute or Standards Council of Canada accredited third-party to comply with the most recent edition of IAPMO/ANSI Z1000 or CSA B66.

(b) The uniform liquid depth shall be at least three (3) feet.

(c) The inside length of the tank shall be at least two (2) times the inside width of the tank.

(2) If thermoplastic tanks having other dimensional characteristics are proposed, specifications must be submitted to the Department for approval, and the proposed design must be demonstrated to provide equivalent effectiveness for storage and distribution to that of concrete or thermoplastic tanks described in this regulation.

(3) Thermoplastic tank manufacturers must renew their product approvals by submitting new applications and plans to the Department every five (5) years and before changing any previously approved plans.

600. License to Clean Onsite Wastewater Systems, Self-Contained Toilets, and Other Sewage Holding Systems (i.e., Licensing of Pumper/Haulers).

600.1. No person shall be responsible for the cleaning of onsite wastewater systems, self-contained toilets, and other sewage holding systems in South Carolina without first applying for, receiving, and subsequently maintaining a valid license to conduct such activities as herein required by the Department. This includes, but is not limited to, nonwater-carried sewage treatment devices and gray water subsurface reuse system.

600.2. Licenses, Applications, and Fees.

(1) License applications, on forms approved by the Department, shall be submitted to the Department's regional environmental office which covers the county where the applicant's primary place of business is located; persons whose primary place of business is out of state must submit their applications to the Department's regional environmental office where it is reasonably anticipated the bulk of the activities sought to be licensed would occur.

(2) The following shall apply to applications submitted by persons engaged in the business of cleaning onsite wastewater systems, self-contained toilets, and other sewage holding systems:

(a) The applicant shall list on the application form each approved septage and sewage disposal facility they intend to use. Written verification of permission to use each disposal facility shall accompany the application.

(b) The applicant shall list on the application form all locations where pumping and transporting vehicles are parked/stored when not in use.

(c) For each annual renewal of an existing license, the person seeking renewal shall submit changes to any information included on the original license application to the Department through an updated application.

(d) Upon request by the Department, each person seeking a new license or renewal of an existing license shall make available for inspection all vehicles and equipment used in the pumping and transporting of septage and sewage.

(e) Additional inspections of vehicles and equipment may be conducted by the Department to ensure compliance with this regulation.

(f) If a licensee replaces, deletes, or adds to their inventory of vehicles used in pumping and transporting septage or sewage, the licensee shall immediately notify the Department for the purpose of updating their application. A vehicle may not be placed into use without prior inspection and approval from the Department.

(3) Prior to receipt of a license authorizing a person to be responsible for the cleaning of onsite wastewater systems, self-contained toilets, and other sewage holding systems, applicants shall complete an examination demonstrating their knowledge and comprehension of this regulation. Any applicant failing to satisfactorily complete the licensing examination may be eligible to retake the examination after thirty (30) calendar days. Applicants who fail to satisfactorily complete their second examination may then be allowed to retake subsequent examinations after a sixty (60)-day waiting period.

(4) A fee shall be assessed for a new license and for the annual renewal of a license.

(a) No person who seeks to be responsible for the cleaning of onsite wastewater systems, self-contained toilets, and other sewage holding systems shall be issued a new license pursuant to this regulation until a fee of one hundred dollars (\$100.00) has been paid to the Department, except that a person applying both for this license (i.e., pumper/hauler license) and an installers license (i.e., license to construct or repair systems) shall pay a fee of only fifty dollars (\$50.00) for the license to clean onsite wastewater systems, self-contained toilets, and other sewage holding systems.

(b) Every license issued by the Department under this regulation shall be valid for a period of one (1) year, unless otherwise suspended or revoked.

(c) Each licensee must pay an annual renewal fee of one hundred dollars (\$100.00), except that a person applying to renew both this license (i.e., pumper/hauler license) and an installers license (i.e., license to construct or repair systems) shall pay a fee of only fifty dollars (\$50.00) for the renewal of the license to clean onsite wastewater systems, self-contained toilets, and other sewage holding systems.

(d) Annual renewal fees shall be due on a date not less than thirty (30) calendar days from the billing date. A penalty charge of thirty dollars (\$30.00) shall be assessed for license fees that are past due. A second penalty of thirty dollars (\$30.00) shall be assessed for license fees sixty (60) days past due.

(e) Expiration of a license shall occur when the license fee is ninety (90) calendar days past due. No person with an expired license may be engaged in the business of cleaning onsite wastewater systems, self-contained toilets, and other sewage holding systems.

(f) An expired license shall not be renewed. Any person with an expired license may apply for a new license and must meet all applicable requirements for a new license.

(5) Licenses issued in accordance with this regulation shall not be transferable.

600.3. Further Governmental Restriction Not Prohibited.

Nothing within this regulation shall be construed to limit the power of any municipal, county, or governmental entity to enforce other license requirements or additional measures for the restrictions of persons cleaning onsite wastewater systems, self-contained toilets, and other sewage holding systems.

600.4. License Not Required.

Public or private sewer providers using pumping and transporting vehicles for the sole purpose of maintaining their sewer systems shall be exempt from the licensing requirements of Section 600 of this regulation. This exemption does not apply to public or private sewer providers using pumping and transporting vehicles to provide cleaning services to the public.

601. Vehicles, Equipment, and Practices.

601.1. All vehicles and equipment used to remove and transport septage and sewage shall be maintained in a manner that will prevent the occurrence of leaks, spills, and other nuisance conditions. All vehicles shall be properly identified.

(1) Hoses, valves, tanks, and other equipment must be maintained in good repair and working order.

(2) All vehicles used to transport septage and sewage must bear the company name and license number in a prominent place on the sides and rear of each vehicle, using letters and numbers that are at least four (4) inches in height.

601.2. The cleaning of septic tanks and similar units and the pumping and transporting of septage and sewage shall be done in a manner that is safe and does not create a hazard to the public health and the environment. The proper cleaning of any septic tank or similar unit shall include the substantial removal of its contents (solids, semi-solids, and liquids).

601.3. Disposal of septage and sewage shall be allowed only at facilities approved by the Department. A licensee may dispose of septage and sewage only at those approved facilities designated by the licensee's application and any renewals or updates of the application.

(1) Discharge of septage and sewage shall be allowed only at those specific locations designated by the owners/operators of approved disposal facilities.

(2) Discharge of septage and sewage into a public sewage collection system, without the consent and permission of the owner/operator of such system, is prohibited.

(3) The storage of domestic wastewater, sewage, or septage in underground or partially buried tanks/subsurface containment units, is prohibited.

601.4. A licensee shall adequately supervise employees and ensure that onsite wastewater systems, self-contained toilets, and other sewage holding systems are cleaned in accordance with this regulation and other applicable regulations, permits, and standards issued by the Department.

602. Records of Operation.

602.1. Each person licensed to clean onsite wastewater systems, self-contained toilets, and other sewage holding systems is required to maintain accurate records of cleaning and transporting activities.

(1) Records shall be kept current and shall include at least the following information for each cleaning/transporting activity:

(a) Date and time of septage and sewage removal.

(b) Name and address of residence or facility where septage and sewage was removed. Where one or more self-contained toilets are cleaned at one location (e.g., construction site, special event, etc.), one recorded entry per location will be acceptable.

(c) Quantity and type of septage and sewage removed (e.g., grease trap, septic tank, self-contained toilet, etc.). Where one or more self-contained toilets are cleaned at one location, quantity may be expressed by the total number of units cleaned at that location.

(d) Date, time, and location of septage and sewage disposal.

602.2. Records shall be made available for inspection by the Department upon request. All licensees must retain their records for a minimum of two (2) years.

700. License to Construct or Repair Onsite Wastewater Systems (i.e. Licensing of Installers).

700.1. License Requirements and Fees.

(1) No person shall be responsible for the construction or repair of onsite wastewater systems in South Carolina without first applying for, receiving, and subsequently maintaining a valid license to conduct such activities as herein required by the Department, provided that a person may construct or repair an onsite wastewater system for personal use at the person's residence without obtaining a license.

(2) Licenses, Applications, and Fees

(a) License applications, on forms approved by the Department, shall be submitted to the Department's regional environmental office which covers the county where the applicant's primary place of business is located; persons whose primary place of business is out of state must submit their applications to the Department's regional environmental office where it is reasonably anticipated the bulk of the activities sought to be licensed would occur.

(b) Prior to receipt of a license authorizing a person to be responsible for the construction or repair of an onsite wastewater system, the applicant shall complete an examination demonstrating the applicant's knowledge and comprehension of this regulation. Any applicant failing to satisfactorily complete the licensing examination may be eligible to retake the examination after thirty (30) calendar days. Applicants who fail to satisfactorily complete their second examination may then be allowed to retake subsequent examinations after a sixty (60) calendar day waiting period.

(c) Each license requires fees for the initial license issuance and annual renewal. The required fees vary depending on the tier of licensure sought. The required initial license and renewal fees for each tier are as follows:

(i) Tier 1 – One hundred dollar (\$100.00) fee

(ii) Tier 2 – One hundred dollar (\$100.00) fee

(iii) Tier 3 – Two hundred dollar (\$200.00) fee

(d) Every license issued by the Department under this regulation shall be valid for a period of one (1) year, unless otherwise suspended or revoked.

(e) Renewal fees shall be due on a date not less than thirty (30) calendar days from the billing date. A penalty charge of thirty dollars (\$30.00) shall be assessed for license fees that are past due. A second penalty of thirty dollars (\$30.00) shall be assessed for license fees sixty (60) days past due.

(f) Expiration of a license shall occur when the license fee is ninety (90) calendar days past due. No person with an expired license may be engaged in the business of constructing and repairing onsite wastewater systems, sewage holding systems, or self-contained toilets.

(g) An expired license shall not be renewed. Any person with an expired license may apply for a new license and must meet all applicable requirements for a new license.

(h) Licenses issued in accordance with this regulation shall not be transferable.

(3) Further Governmental Restriction Not Prohibited

Nothing within this regulation shall be construed to limit the power of any municipal, county, or governmental entity to enforce other license requirements or additional measures for the restrictions of persons constructing or repairing onsite wastewater systems.

(4) Eligibility

Only a person who meets the following criteria is eligible to be licensed as an onsite wastewater systems installer:

(a) Applicants to be a Tier 1 or Tier 2 installer must:

(i) Pass an examination administered by the Department with a minimum score of eighty (80) percent; and

(ii) Submit a properly completed application with supporting documents including proof of continuing education units (CEUs) for any renewal; and

(iii) Pay applicable fees.

(b) Applicants to be a Tier 3 installer must:

(i) Qualify as either:

(A) A licensed onsite wastewater system installer who has been actively installing for three (3) years immediately preceding the date of application with no pending or prior disciplinary or enforcement action involving onsite wastewater system contracting; or

(B) An onsite wastewater system installer licensee from another state with affidavits from the regulatory authority demonstrating five (5) years of experience with no pending or prior disciplinary or enforcement action involving onsite wastewater system contracting; and

(ii) Pass an examination administered by the Department with a minimum score of eighty (80) percent;

(iii) Submit a properly completed application with supporting documents (if required);

- (iv) Submit proof of continuing education units (CEUs) for any renewal;
- (v) Submit proof of required Bond and insurance coverage; and
- (vi) Pay applicable fees.

701. Continuing Education and Training.

701.1. All installers are required to complete the necessary number of continuing education units (CEUs) every two (2) years from the date of licensing to renew the installer license. CEUs must be obtained from the Department-approved list of courses and providers.

701.2. The Department will not renew a license for any installer who has failed to meet the training and education requirements for the previous licensing period.

701.3. If any installer completes more than the required hours in a licensing period, as many as three (3) hours can be rolled over and credited to the requirement for the next licensing period.

701.4. The required CEUs for each Tier for every two (2) year licensing period are as follows:

- (1) Tier 1: Eight (8) hours
- (2) Tier 2: Twelve (12) hours
- (3) Tier 3: Eighteen (18) hours

701.5. Implementation of CEU Requirement.

The requirement for CEUs will enter into effect for any initial or renewal licensing period beginning on or after the date three (3) years following the effective date of this regulation.

702. Practice, Procedure, and Quality Control.

702.1. Practices: All Installers.

(1) A licensee shall adequately supervise employees and ensure that all onsite wastewater systems for which the licensee is responsible are constructed and repaired in accordance with this regulation and other applicable regulations, permits, and standards issued by the Department. Onsite wastewater systems must be installed pursuant to and in compliance with permits to construct issued by the Department.

(2) An installer does not have the authority to make any changes to a construction or repair project that deviate from an issued permit without first obtaining Department approval.

(3) Installers do not have the authority to subcontract unlicensed installers to conduct work under their licenses.

(4) The specific scope of activities authorized under each tier of licensure is set forth in this regulation's definition of "licensed onsite wastewater system installer." A licensed installer is prohibited from performing any construction or repair that is inconsistent with the scope of activities authorized under the licensee's applicable tier.

702.2. Onsite Wastewater System Installer Self-Inspections.

(1) All Tier 3 installers and Tier 1 or Tier 2 installers directed to perform self-inspections under Section 104.3(1)(c) shall provide the Department the opportunity to perform a final inspection and shall arrange with the Department in advance a time for the final inspection of an onsite wastewater system that is being installed. If, after thirty (30) minutes of that arranged time, the Department representative has not arrived for the inspection, the installer shall:

- (a) Inspect the system;
- (b) Record the findings on a form approved by the Department; and
- (c) Cover the system.

(2) It shall be considered a violation of this regulation to conduct a self-inspection of a system or cover a system without first scheduling a final inspection time with the Department and waiting the full thirty (30) minutes of the arranged time for the Department to conduct a final inspection.

(3) The installer shall not cover a system or seek Department final approval for a system that, upon inspection, is determined not to be in compliance with the permit to construct.

(4) Documentation of system installation and self-inspection using the Department-approved format, including the installer's signature and license number, as well as the system measurements and other specified information, shall be submitted to the Department within two (2) business days of the final self-inspection date. A copy of this document(s) must also be furnished to the property owner for whom the system was installed. Failure to submit to the Department the required documentation within the required timeframe shall be considered a violation of this regulation.

(5) An onsite wastewater system shall not be placed into operation unless and until the Department has issued a final approval to operate.

702.3. Quality Control: Installers.

The Department will conduct random final inspections on no less than three (3) percent annually of the total number of systems installed during the preceding fiscal year. The Department will also conduct field reviews of final installation and inspection documentation submitted by the installer and compare them to the actual installations those documents represent.

703. Bonding and Insurance Requirements: Tier 3 Installers.

703.1. Proof of both insurance and bond coverage shall be furnished to the Department prior to licensure as a Tier 3 installer and upon license renewal.

703.2. An onsite wastewater system Tier 3 installer shall be responsible for obtaining and maintaining both insurance and bond coverage for as long as the installer is licensed as a Tier 3 installer.

703.3. Failure to maintain both insurance and bond coverage shall result in the suspension or revocation of the Tier 3 installer license.

704. Transition to Tiered Licensure.

Upon the effective date of the tiered licensure provisions (Section 700) of this regulation, all installers licensed as master contractors under the previous R.61-56.2 shall be considered to hold a Tier 3 license, and all other installers licensed under the previous R.61-56.1 shall be considered to hold a Tier 2 license. The Tier 3 or Tier 2 license shall expire upon the original expiration date of the license held under R.61-56.1 or R.61-56.2, as applicable, unless the license is renewed in accordance with the provisions of Section 700.1 of this regulation.

800. Enforcement.

800.1. Violations of this regulation shall be punishable in accordance with S.C. Code Sections 44-1-150, 44-55-825, 48-1-320, and 48-1-330. The Department may seek enforcement, suspend and revoke permits and licenses, issue civil penalties, and order corrective action in accordance with law. The Department shall have the authority to suspend civil penalties if the violations of this regulation are corrected in a period of time established by the Department.

800.2. Deviation from the installation design and conditions in onsite wastewater permits to construct and approvals to operate may be considered a violation of this regulation.

800.3. Suspension and revocation of permits to construct and approvals to operate an onsite wastewater system, nonwater-carried sewage treatment system, wastewater combustion system, or gray water subsurface reuse system.

(1) The Department may temporarily suspend a permit to construct or approval to operate for a violation of this regulation.

(2) The Department may revoke a permit to construct or approval to operate for a violation of this regulation. The Department will revoke a permit or approval when:

(a) The onsite wastewater system, nonwater-carried sewage treatment system, wastewater combustion system, or gray water subsurface reuse system is malfunctioning and sewage is discharging to the ground or the groundwater, the holder of the permit has received notice that the system is malfunctioning, the Department has given notice that repairs must be made within a reasonable period of time, the holder of the permit has not made the repairs, and the system continues to discharge sewage to the ground or the groundwater; or

(b) The onsite wastewater system, nonwater-carried sewage treatment system, wastewater combustion system, or gray water subsurface reuse system is malfunctioning and sewage is discharging to the ground or the groundwater, the holder of the permit has received notice that the system is malfunctioning, the Department has given notice that a wastewater treatment facility is accessible for connection.

800.4. Enforcement against persons licensed to construct, clean, and/or repair onsite wastewater systems.

(1) A licensee shall be subject to suspension, revocation, and civil penalties as provided in Sections 800.1 and 800.4(2) for the construction, cleaning, or repair of onsite wastewater systems, self-contained toilets, and other sewage holding systems in violation of state laws, regulations, and standards.

In determining whether a license should be suspended or revoked, the Department may consider such factors as the seriousness of a violation and whether a violation is a repeat of previous violations, among

any other relevant factors. The interference by a licensee or their employees with a representative of the Department in performing their duties with respect to this regulation shall constitute grounds for revocation of license.

(2) Violation of an onsite wastewater system installation permit or any provisions of this regulation by a licensed onsite wastewater system installer or person licensed to clean onsite wastewater systems must be enforced as follows:

(a) First offense violations may be enforced under S.C. Code Section 44-1-150 or by suspension of the license for a period not to exceed one (1) year.

(b) Second offense violations shall be enforced under S.C. Code Section 44-1-150 or by suspension of the license for a period not to exceed three (3) years.

(c) Third offense violations shall be enforced under S.C. Code Section 44-1-150 or by permanent revocation of the license.

(3) The Department may suspend licenses for failure to pay a civil penalty required pursuant to a Department order.

800.5. Prior to suspending or revoking a permit to construct, approval to operate, or license, the Department shall provide written notification to the person stating the basis for suspension or revocation. A permit to construct, approval to operate, or license may be summarily suspended by the Department without prior warning if the Department determines there is an immediate threat to public health.

801. Severability Clause.

Should any section, paragraph, sentence, clause, or phrase of this regulation be declared unconstitutional or invalid for any reason, the remainder of this regulation shall not be affected thereby.